

# KudosPro & KudosPro-IQ

## Single, Dual and Quad Channel Format and Frame Rate Conversion



Supporting all broadcast formats, offering the widest range of I/O connectivity, including IP, and delivering a complete processing toolkit, KudosPro is a dependable solution for even the most unexpected situations.

### Three Ranges for All Applications

KudosPro is the next-generation audio and video processing platform from Grass Valley, a Belden Brand, delivering high-quality audio and video signal processing in a compact, affordable, format-flexible package. KudosPro is the ideal solution for broadcasters, news agencies, and content providers needing to consider cost and space issues, while also ensuring high-quality content for domestic and international audiences. Redundant power supplies in all models, plus comprehensive support means all KudosPro ranges work for your business, and keep working for your business.

#### Utility Series

- Audio video processors for standalone conversion and processing applications
- Single, dual and quad video channel options
- Massive audio processing capabilities all in compact 1 RU chassis with front panel controls.

#### International Series

- Audio video processors for standalone conversion and processing applications
- Framerate/standards conversion using linear interpolation techniques
- Single, dual and quad video channel options
- Massive audio processing capabilities all in compact 1 RU chassis with front panel controls

#### Motion Series

- Audio video processors for standalone conversion and processing applications
- High-quality motion compensated framerate/standards conversion
- Single and dual video channel options plus massive audio processing capabilities
- All in compact 1 RU chassis with front panel controls

### Highest Quality/Highest Density

KudosPro offers up to eight video processing channels in both Utility and International series in 1 RU for the best conversion density in the industry. With IP interfaces the Utility and International series can offer up to four processing channels with IP inputs and outputs complying with the new SMPTE ST 2110 standard.

### Maximum Interfacing and Audio Processing

KudosPro products offer a full range of input and outputs via physical interfaces, so whatever your interfacing challenges, Grass Valley can help. Audio processing capabilities across the range are comprehensive via embedded, discreet or analog inputs and outputs.

### Enhanced Processing with Modular Cards

Utility, International and Motion ranges can be supplied in IQ variants allowing the inclusion in the 1 RU rack frame of up to two IQ modular cards. For example, with the Motion range's KudosPro MC2000-IQ, the addition of two IQMCC30 cards makes four fully motion compensated conversion channels in 1 RU.

### Dedicated IP Solution Variants

By using the IQ variants and the Grass Valley IQMIX or IQUCP cards, KudosPro processing units can be a core component of your new IP system.

With this approach, up to four broadcast-quality processing channels with IP inputs and outputs conforming to SMPTE ST 2110 are available in just 1 RU. Of course, all the control and monitoring plus redundant power supplies are built in.

## MC500, MC1000-IQ, MC2000 and MC2000-IQ

### Motion Compensated Standards Conversion

Motion compensated single channel (MC500 & MC1000-IQ) and dual channel (MC2000 & MC2000-IQ) SD/HD/3G frame rate converter with powerful enhancement and processing tools.

### Affordable International Program Exchange

The superb standards conversion capabilities of MC500, MC1000-IQ and MC2000 enable program makers and content owners to offer high-quality material to worldwide customers, while keeping project costs down.

## LC2000 and LC4000

### Linear Motion Adaptive Standards Conversion

Dual channel (LC2000) and quad channel (LC4000) SD/HD/3G linear frame rate converter with motion adaptive up-, down- and crossconversion.

### High Density Conversion

Immediate and flexible selection of a wide range of digital and analog input and output formats, from SD up to 3 Gb/s.

## UHD1100, UHD1200, SV2000 and SV4000

### Linear Motion Adaptive Format Conversion

Single channel (UHD1100/1200), dual channel (SV2000) and quad channel (SV4000) SD/HD/3G/4K UHD video and audio processing including up-, down- and crossconversion.

### Saving Production Costs

Smoothly integrate mixed SD/HD/3G/4K UHD produced content or incoming feeds ready for any outgoing transmission standard.

### High Density Plus!

Not only do KudosPro products offer high density conversion opportunities (up to four channels in a 1 RU box), there's also the option to add up to two of Grass Valley's IQ modules to further enhance the capability and functionality of your system, without impacting on facility space.

### HD and Beyond

Viewers of SD and HD services can continue to watch their favorite programs, even with transitional 3 Gb/s, HD and SD production workflows, through the provision of the quality assured up, down and cross-conversion capabilities — ensuring valuable content assets remain viable for the long-term future in any format.

### Flexible Workflows

Flexible, automated processing is another important capability within the KudosPro range. Sources can be switched between 3 Gb/s, HD and SD, and with all KudosPro products supporting automatic input detection, the most appropriate conversion mode can be immediately offered.

Full support for important metadata such as Closed Captions, timecode and AFDs is all provided as standard.

### Simple and Intuitive Control

A simple web interface, as well as control via Grass Valley's award winning RollCall software (free to download from the Grass Valley website), are available on all KudosPro products, enabling KudosPro to fit into any broadcast, playout or post-production workflow.

User control via simple front panel menus and short-cut buttons enables artistic decisions to be easily actioned, and the intuitive front panel display gives instant reassurance of the current system status.

## Table of Contents

---

Introduction .....	3	<b>MC1000-IQ and MC2000-IQ</b>	
<b>MC2000</b>		Motion Compensated Standards Converters .....	19
Motion Compensated Standards Converters .....	6	<b>LC2000-IQ and LC4000-IQ</b>	
<b>MC500</b>		Motion Adaptive Standards Converters .....	22
Motion Compensated Standards Converter .....	8	<b>SV2000-IQ and SV4000-IQ</b>	
<b>LC2000</b>		Up/Down/Crossconverters.....	25
Motion Adaptive Standards Converter.....	10	Customize your KudosPro-IQ Unit by adding Grass Valley	
<b>UHD1200</b>		IQ Modules.....	28
12G UHD Video & Audio Processor .....	12	Application Example: Adding IQOTX80 — 3G/HD/SD-SDI	
<b>UHD1100</b>		Multichannel Fiber Transmitter .....	29
4K UHD-1 Video & Audio Processor .....	14	Cost-effective Conversion.....	29
<b>SV2000 and SV4000</b>		<b>KudosPro-IP</b>	
Up/Down/Crossconverters.....	16	Video and Audio Processing for IP Systems.....	30

Whatever your conversion needs, the KudosPro range offers superb quality results.

All broadcast frame rates and formats are supported, ensuring great quality conversion for international content sources resulting in programs that look stunning, and give you an edge over competing channels.

### Solves your Format Problems

The KudosPro range produces the consistent, high standard, 1080p, HD and SD pictures that viewers demand, with reliability and customer service expected from the Grass Valley brand, and its years of experience in conversion and signal processing products.

### Peace of Mind

Rest assured that KudosPro is always ready to fix your signal problems, no matter how expected or unexpected they may be. The comprehensive feature set includes: audio delay/gain/shuffling, legalizer, user selectable aspect ratio conversion, logo insertion, side-bar keying, extensive picture enhancement tools and noise reduction.

### Ease of Use

Integrating legacy and international programming into your schedules has never been easier. With Grass Valley's KudosPro range of converters, you're guaranteed to find a converter to meet your application and budget needs. Whether you need to frame rate or format convert, Grass Valley offers motion compensated and motion adaptive converters that ensure that the quality of your content is retained at every step in your workflow.

Ideal for international program exchange, conversion, high-density distribution and content repurposing for internet, TV and Blu-ray

### Stills

KudosPro achieves maximum resolution preserving the fine detail in graphics and sharpness of text. Softness and lack of detail are typical artifacts which are seen in other products.

### Action

In fast moving sports action, detail and definition around key parts of the images such as the ball or player are critical. KudosPro uses motion compensation to ensure full resolution and well defined motion. It is the only product that provides full resolution moving video images. Other products introduce blur and reduce resolution in moving areas.

### Complex pictures

A typical program output comprises many components such as station branding, credit rolls and video or animation. KudosPro handles all of these simultaneously without compromise. Other products cannot handle these types simultaneously. Image quality will be compromised.





Control is offered from the attractive and user-friendly front panel as well as a simple web interface. For large system users, Grass Valley offers a free control application (RollCall).

**Front Panel Control**

User control via simple front panel menus and short-cut buttons enables artistic decisions to be easily actioned, while the intuitive front panel display gives instant reassurance of the current system status.

**Remote Control**

Control using a web browser or RollCall control panel (Grass Valley’s proprietary control and monitoring application) is also available. Alternatively integrate into enterprise-wide control & monitoring systems using SNMP.

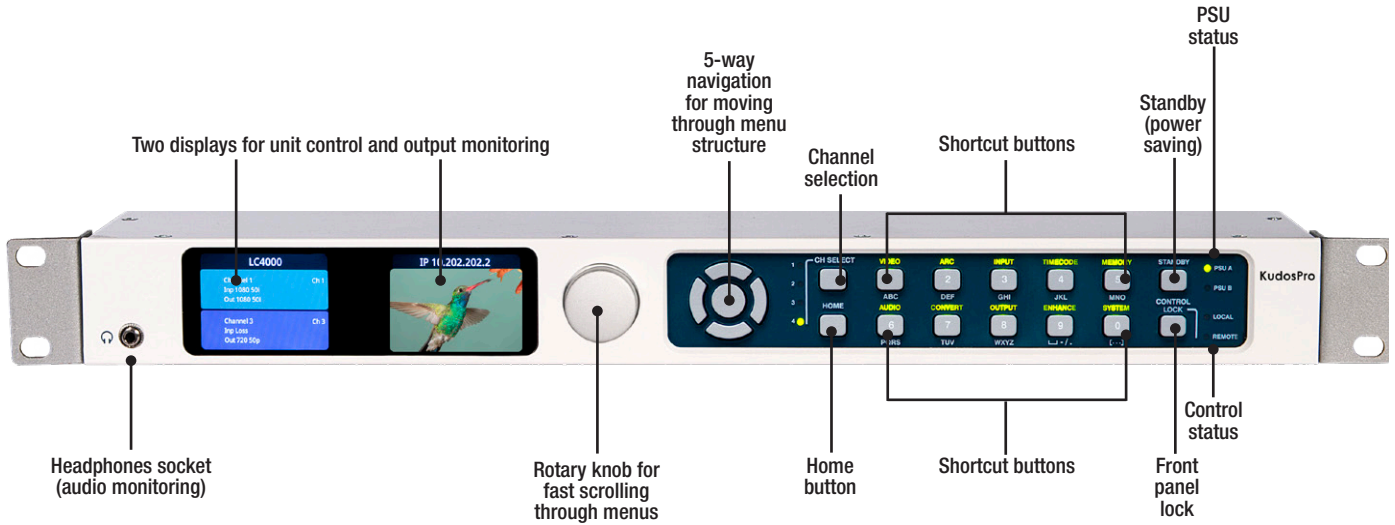

KudosPro offers the widest range of I/O connectivity and delivers a complete processing toolkit.

The KudosPro range has an array of digital and analog interfaces encompassing video formats from composite to 1080p, copper to fiber and a comprehensive selection of audio handling options and formats, including analog and AES — both balanced and unbalanced.

**Video I/O**

With both SDI and analog composite video interfaces, KudosPro is a completely flexible platform, handling SD, HD and 1080p over SDI or fiber.

**Audio I/O**

AES I/O is available as balanced or unbalanced, providing complete flexibility no matter what environment you’re in. Analog audio can be embedded and de-embedded into SD/HD/3G.

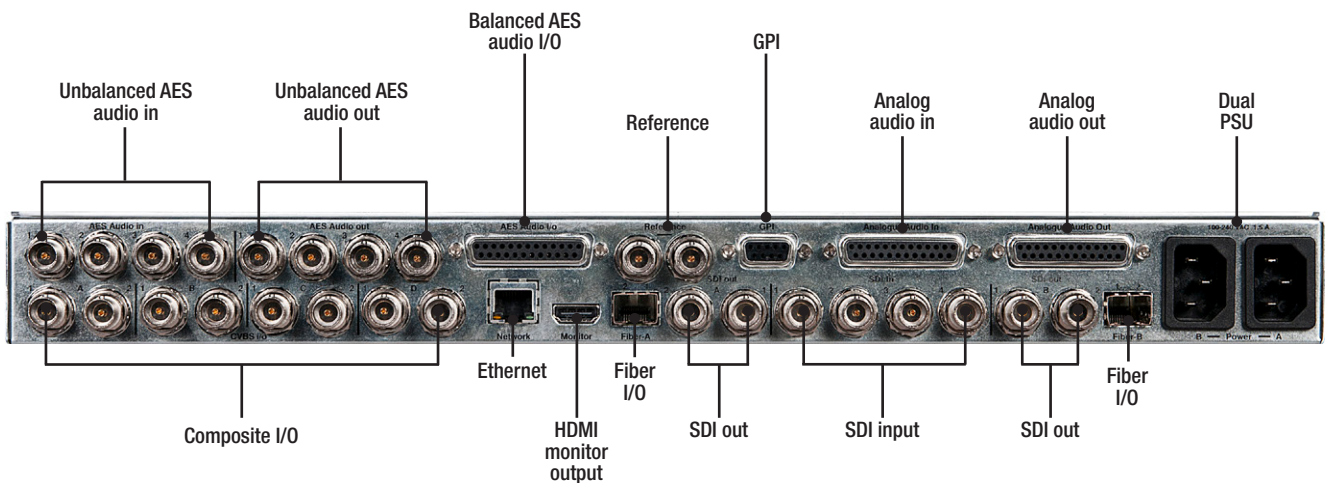

Not only do KudosPro products offer high-quality, affordable conversion within a compact enclosure, they also offer single-, dual- and quad-channel frame synchronization with advanced video and audio processing capability, all within 1 RU, making KudosPro ideal for high-density production environments demanding the widest range of conversion possibilities — now and into the future.

Convert from any SD/HD/3G standard to any other SD/HD/3G 1080p standard, including 1080 and 720 23/24/25/29p and psf. Create simultaneous HD and SD outputs from one input source (not applicable to MC500/MC1000-IQ). Choose from linear motion adaptive format conversion through to motion compensated standards conversion, or select frame synchronization and relay bypass on primary SDI inputs.

Powerful picture enhancement tools:

- Noise reducer
- Enhancer
- Legalizer
- Proc Amp

Additional video processing features, including:

- Logo insertion (one per channel)
- Side-bar keying
- Multi-line WST, closed caption and AFD aspect ratio conversion features

Up to 16-channels of embedded audio processing are available for each video channel including Dolby-E guard-band alignment. Audio handling includes; audio embedding, audio de-embedding, audio gain, audio delay, audio shuffle and audio swap.

### Applications

#### OB Truck/Studio

Work with up to four channels of SD and HD content simultaneously in any form within a single 1 RU enclosure. KudosPro adapts with you, and on demand, because we recognize that no two events are ever the same.

#### Post/Facility Production

From 23.98, 24, 25 to 50p and 60p KudosPro converts seamlessly between all international standards with the quality you'd expect from Grass Valley, at an incredibly affordable price point.

#### Ingest

Handle multiple channels within the 1 RU high-density design for use in front of our ingest servers, bringing content into your house format — no matter what format it is originally received/stored in. KudosPro quickly “fixes” audio & video problems.

#### Hire

Never really know what your clients are going to ask for? Don't worry. KudosPro has complete analog and digital flexibility from analog audio with composite to 1080p 3 Gb/s with AES audio. Plus the user interface is simple and intuitive, so you won't have calls asking how to set up and use the unit(s).

#### Satellite, Head-End Application

Remote control and monitoring and dual PSUs give you the reliability and peace of mind critical for remote locations.



# MC2000

## Motion Compensated Standards Converters

The MC2000 is a cost-effective motion compensated standards converter.



### KEY FEATURES

- Motion compensated SD/HD/3G frame rate conversion
- SD/HD/3G up-, down- and crossconversion
- Independent dual channel conversion
- Flexible video and audio I/O configuration
- 16-channel embedded audio processing for each video channel
- Continuous output when input standard switches
- HDMI monitor output
- Dual PSU as standard
- Relay bypass on primary SDI inputs
- Automatic aspect ratio conversion (AFD, VI, L23)
- Powerful picture enhancement tools
- Front panel and remote control via web interface and RollCall
- Closed caption and timecode handling
- Synchronization
- User chosen line for SMPTE ST 2016

- GPI support
- Front panel control lock
- SMPTE ST 2020 metadata support
- Caption generator
- Logo inserter
- Sidebar keyer
- Clean cut
- Composite input/output
- Fiber input/output

### Applications

- International program distribution
- Content repurposing for internet, TV and Blu-ray distribution
- International TV and video production

### MC2000 Video Processing

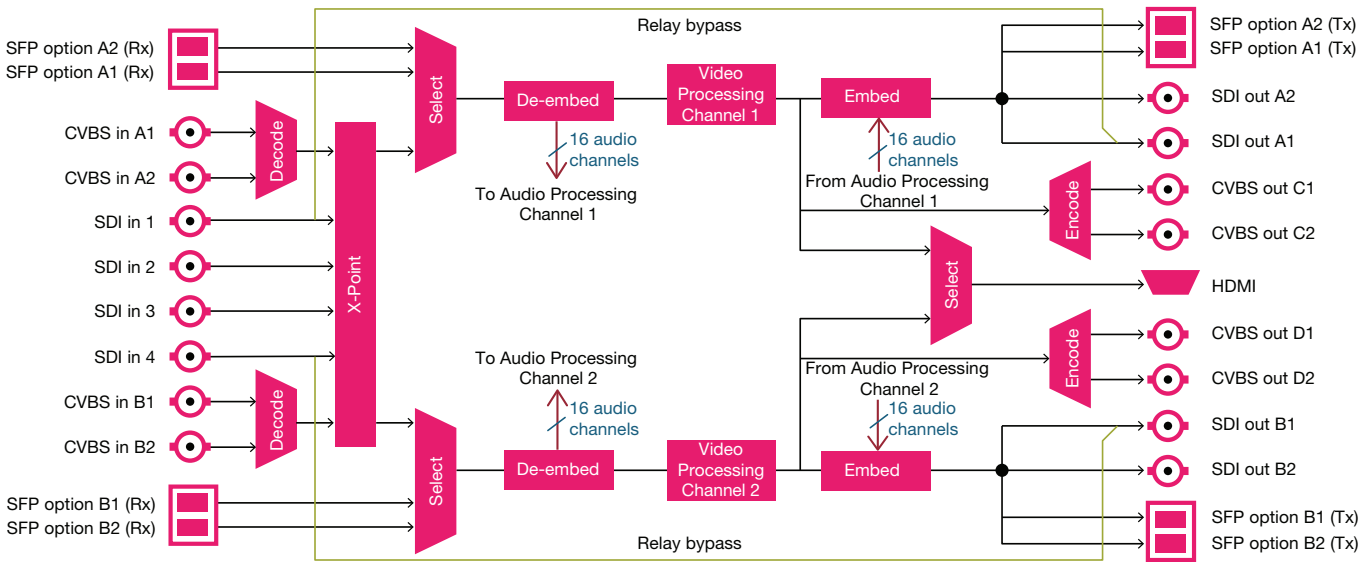

### MC2000 Audio Processing

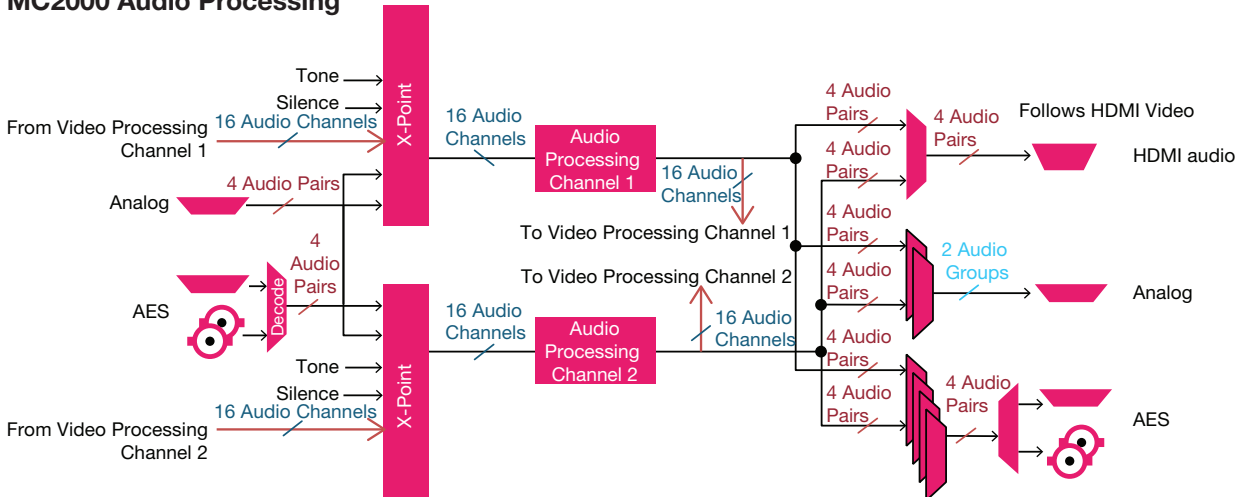

## SPECIFICATIONS

### Signal Inputs

Serial digital 4x 75Ω SD/HD/3G serial digital with embedded audio

#### Input standards:

- 3 Gb/s SD-SDI, SMPTE ST 425 level A, level B
- 1.5 Gb/s HD-SDI SMPTE ST 292/SMPTE ST 299
- 270 Mb/s SD-SDI SMPTE ST 259

Composite PAL, NTSC, NTSC-J, PAL-M, PAL-N, N4.4, SECAM

12-bit ADCs

Analog component YC

**Reference:** 1 x loop-through HDTV Trisync/SD Bi-sync (black & burst): SMPTE ST 240/SMPTE ST 274

#### Audio AES:

- 4x balanced AES inputs – via 25-way D-Type
- 4x unbalanced AES inputs – via 4x BNC

**Audio analog:** 4x stereo analog inputs via 25-way D-Type

### Signal Outputs

Serial digital 4x 75Ω SD/HD/3G serial digital with embedded audio

#### Output standards:

- 3 Gb/s HD-SDI, SMPTE ST 425 level A, level B
- 1.5 Gb/s HD-SDI SMPTE ST 292/SMPTE ST 299
- 270 Mb/s SD-SDI SMPTE ST 259

Composite PAL, NTSC, NTSC-J, PAL-M, PAL-N, 12-bit DACs

Analog component YC

#### Audio AES:

- 4x balanced AES outputs – via 25-way D-Type
- 4x unbalanced AES outputs – via 4x BNC

**Audio analog:** 2x stereo analog outputs via 25-way D-Type

### Input Standards

(auto detect) 525, 625

720 50/59.94/60p

1080 50/59.94/60i

1080 50/59.94/60p (Levels A and B)

720/1080 23/24/25/29/30p

1080 23/24/25/29psf

### Output Standards

525, 625

720 50/59.94/60p

1080 50/59.94/60i

1080 50/59.94/60p (Levels A and B)

720/1080 23/24/25/29/30p

1080 23/24/25/29psf

### Conversion Functions

**Modes:** SD/HD/3G Motion Compensated

**Standards Conversion:** Upconversion, Down-conversion, Crossconversion

Conversion Linear/motion compensated Conversion processing

**Still process:** Detects still images and applies an aperture with full (progressive) vertical frequency response

**Enhanced still:** Adds field motion detection to still process. Prevents artifacts on moving repetitive patterns

### Manual or Automatic ARC

AFD (SMPTE ST 2016), VI (RP186), WSS (L23)

**SD input format:** Normal 4:3, Anamorphic 16:9, Letterbox 14:9, Letterbox 16:9

**SD output format:** Normal 4:3, Anamorphic 16:9, Letterbox 14:9, Letterbox 16:9

**Auto zoom:** On/Off

**Manual zoom:** Zoom ±20%

**Safe area marker:** Off, 16:9, 4:3

**Manual controls:** size, aspect, pan, tilt

Wide range of ARC presets including 702 sample line mode

### Audio Functions

#### Analogue Audio:

Four pairs of analog inputs are individually available to any or all processing channels

Two groups (2 pairs) of analog output are separately assignable to any processing channel

Headroom +24 dBu; balanced connection

#### AES Audio:

Four AES audio inputs are individually available to any or all processing channels

Four AES audio outputs (48 kHz) are separately assignable to any processing channel  
AES input is auto-detected as PCM (32-96 kHz) or non-PCM (48 kHz locked to relevant video input)

#### Embedded Audio:

Each processing channel includes 16-channel embedded audio processing

PCM audio processing includes channel level gain and delay compensation, as well as channel level routing/shuffle with audio phase inversion

Non-PCM processing features pair level routing and delay compensation

Dolby-E data is passed with a delay to match the video and with co-timed audio frame drop or repeat

### Metadata

Closed caption CEA608 <> CEA708

Timecode conversions

WST/RDD8 conversion

SMPTE ST 2020 embed/de-embed

### Enhancement

#### Advanced Horizontal Enhancement:

- Frequency band selection (Low, Med, High)
- 4 preset enhancement levels (Soft 2, Soft 1, Normal, Sharp 1, Sharp 2)
- Custom H Gain and H Noise rejection levels

#### Advanced Vertical Enhancement:

- Frequency band selection (Low, Med, High)
- 5 preset enhancement levels (Soft, Normal, Sharp 1, Sharp 2, Sharp 3)

#### Horizontal Aperture:

- 5 preset H sharpness levels (Low 2, Low 1, Normal, High 1, High 2)
- 5 preset H detail levels (Soft 2, Soft 1, Normal, Sharp 1, Sharp 2)

#### Noise reduction:

spatial, recursive  
Y/C alignment: corrects for up-stream luma chroma displacement

### System

Pattern Off, Black, Ramp, Bars

Proc amp

**Black Level:** +100 to -100 mV (0) in 0.8 mV steps

**Contrast:** -6 dB to +6 dB (0) in 0.2 dB steps

**Saturation:** -6 dB to +6 dB (0) in 0.2 dB steps

**Y Gamma:** 0.4 to 1.7 (1) in 0.1 steps

**Freeze:** On/Off

**Genlock:** Reference lock, Input lock (same format), Follow input (same frame rate), Free run

**Memories:** 16 user memories

Legalizer

EDH support

### Communications

Remote control via web interface and RollCall network (IP)

### Power (Primary and Secondary)

**Input voltage range:** 100 – 240 VAC, 50/60 Hz 1.5A (max.) via three-pin IEC power socket

### Mechanical

**Temperature range:** 0 to 45° C (32° to 113° F) operating

**Cooling:** Internal fan, side venting

**Weight:** Approximately 4.25 kg (9.4 lbs.)

**Case type:** 1 RU, rack mounting

**Dimensions:** 44 x 430 x 400 mm (1.7 x 16.9 x 15.7 in.) (HxWxD)

Headphones socket with volume control

**GPIO:** 8 available

### Throughput Delay

#### Video processing delay:

**Field = 16.7 or 20 ms**

**Frame = 33.3 or 40 ms**

With scaling active in same frame rate:

Ref lock/Free run – Between 3 and 5 fields + ~200 µs

Input lock (SDI) – 3 fields + 1 ms

With same standard in & out and sync mode = Enabled:

Ref lock/Free run – Between ~200 µs and 1 frame + ~200 µs

Input lock (SDI) – ~1 ms

Frame rate conversion: Any lock mode – 110 ms typical

#### Audio processing delay: (Audio delay = 0 ms)

With scaling active in same frame rate:

Ref lock/Free run – 1.5 frames

Input lock – 1 frame + 1 ms

With same standard in & out and sync mode = Enabled:

Ref lock Free run – 0.5 frames

Input lock – ~3 ms

Frame rate conversion: Any lock mode – 110 ms typical

## ORDERING

### 6132100

MC2000-CT2 Dual channel motion compensated frame rate converter and adaptive format converter. Including frame synchronization, ARC control, noise reduction, side-bar keying, logo insertion, CC, WST and timecode handling, picture enhancement tools, 16-channel audio processing inc gain, delay & shuffling. SD, HD and 3G-SDI (BNC or fiber), CVBS, GPI, AES and analog audio I/O. HDMI monitor output & dual PSUs.

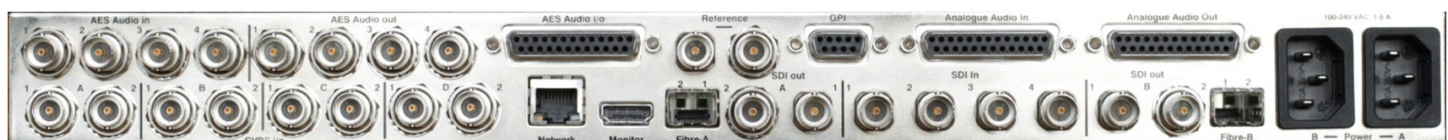

Rear panel shows MC2000 with CVBS option fitted.

# MC500

## Motion Compensated Standards Converter

The MC500 is a cost-effective motion compensated standards converter.



### KEY FEATURES

- Motion compensated SD/HD/3G frame rate conversion
- SD/HD/3G up-, down- and crossconversion
- Flexible video and audio I/O configuration
- 16-channel embedded audio processing for each video channel
- Continuous output when input standard switches
- HDMI monitor output
- Dual PSU as standard
- Relay bypass on primary SDI inputs
- Automatic aspect ratio conversion (AFD, VI, L23)
- Powerful picture enhancement tools
- Front panel and remote control via web interface and RollCall
- Closed caption and timecode handling
- Synchronization
- User chosen line for SMPTE ST 2016

- GPI support
- Front panel control lock
- SMPTE ST 2020 metadata support
- Caption generator
- Logo inserter
- Sidebar keyer
- Clean cut
- Composite input/output (also adds AES and analog audio)
- Fiber input/output

### Applications

- International program distribution
- Content repurposing for internet, TV and Blu-ray distribution
- International TV and video productions

### MC500 + CVBS (6143110)

#### Video Process

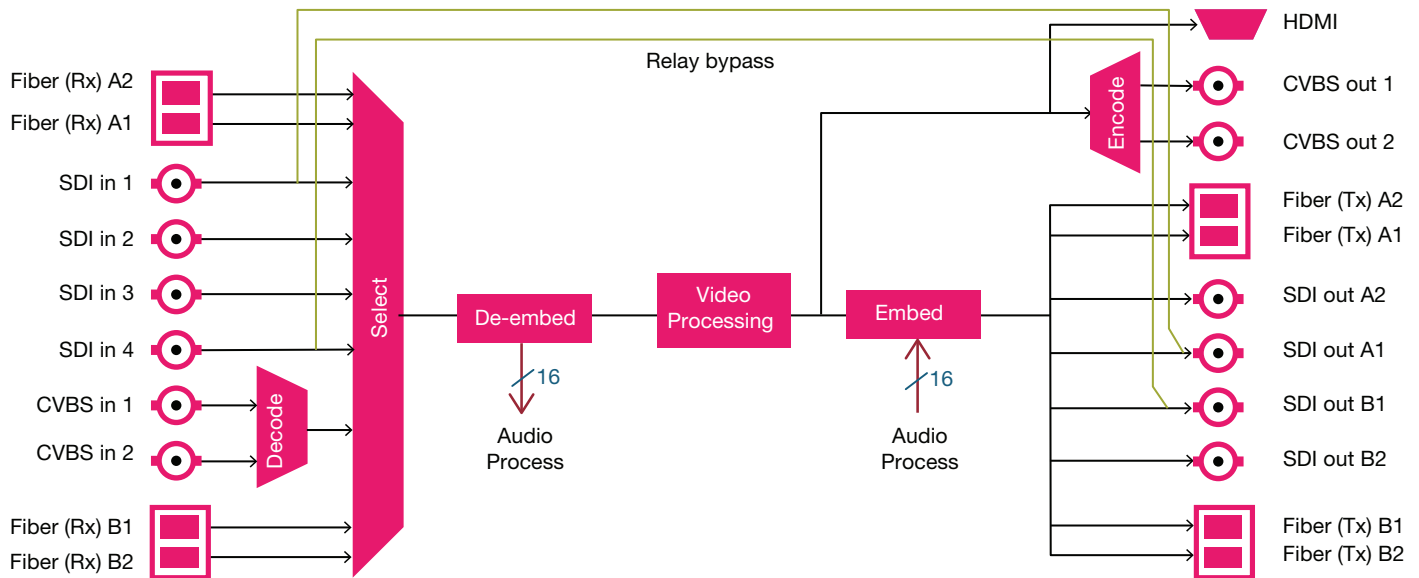

#### Audio Process

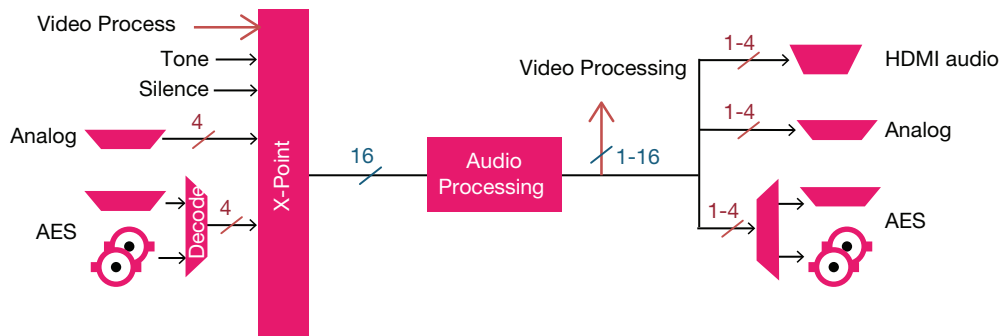

16 = Channels  
4 = Pairs



## SPECIFICATIONS

### Signal Inputs

Serial digital 4x 75Ω SD/HD/3G serial digital with embedded audio

#### Input standards:

- 3 Gb/s HD-SDI, SMPTE ST 425 level A, level B
- 1.5 Gb/s HD-SDI SMPTE ST 292/SMPTE ST 299
- 270 Mb/s SD-SDI SMPTE ST 259

Composite PAL, NTSC, NTSC-J, PAL-M, PAL-N, N4.4, SECAM (option)

12-bit ADCs

Analog component YC

**Reference:** 1x loop-through HDTV Trisync/SD

**Bi-sync (black & burst):** SMPTE ST 240/SMPTE ST 274

#### Audio AES:

- 4x balanced AES inputs – via 25-way D-Type
- 4x unbalanced AES inputs – via 4x BNC

**Audio analog:** 4x stereo analog inputs via 25-way D-Type

### Signal Outputs

Serial digital 4x 75Ω SD/HD/3G serial digital with embedded audio

#### Output standards:

- 3 Gb/s HD-SDI, SMPTE ST 425 level A, level B
- 1.5 Gb/s HD-SDI SMPTE ST 292/SMPTE ST 299
- 270 Mb/s SD-SDI SMPTE ST 259

Composite PAL, NTSC, NTSC-J, PAL-M, PAL-N, (option)

12-bit DACs

Analog component YC

#### Audio AES:

- 4x balanced AES outputs – via 25-way D-Type
- 4x unbalanced AES outputs – via 4x BNC

**Audio analog:** 2x stereo analog outputs via 25-way D-Type

### Input Standards

(auto detect) 525, 625, 720 50p 59.94p, 1080 50i, 59.94i, 1080 50p 59.94p

### Output Standards

525, 625, 720 50p 59.94p, 1080 50i 59.94i, 1080 50p 59.94p

### Conversion Functions

**Modes:** SD/HD/3G Motion Compensated

**Standards Conversion:** Upconversion, Down-conversion, Crossconversion

Conversion Linear/motion compensated  
Conversion processing

**Still process:** Detects still images and applies an aperture with full (progressive) vertical frequency response

**Enhanced still:** Adds field motion detection to still process. Prevents artifacts on moving repetitive patterns.

### Manual or Automatic ARC

AFD (SMPTE ST 2016), VI (RP186), WSS (L23)

**SD input format:** Normal 4:3, Anamorphic 16:9, Letterbox 14:9, Letterbox 16:9

**SD output format:** Normal 4:3, Anamorphic 16:9, Letterbox 14:9, Letterbox 16:9

**Auto zoom:** On/Off

**Manual zoom:** Zoom ±20%

**Safe area marker:** Off, 16:9, 4:3

**Manual controls:** size, aspect, pan, tilt

Wide range of ARC presets including 702 sample line mode

### Audio Functions

#### Analog Audio (only available with CVBS option)

Four pairs of analog inputs are individually available to any or all processing channels

Two groups (2 pairs) of analog output are separately assignable to any processing channel

Headroom +24 dBu; balanced connection

#### AES Audio (only available with CVBS option)

Four AES audio inputs are individually available to any or all processing channels

Four AES audio outputs (48 kHz) are separately assignable to any processing channel  
AES input is auto-detected as PCM (32-96 kHz) or non-PCM (48 kHz locked to relevant video input)

### Embedded Audio

Each processing channel includes 16-channel embedded audio processing

PCM audio processing includes channel level gain and delay compensation, as well as channel level routing/shuffle with audio phase inversion

Non-PCM processing features pair level routing and delay compensation

Dolby-E data is passed with a delay to match the video and with co-timed audio frame drop or repeat.

### Metadata

Closed caption CEA608 <> CEA708

Timecode conversions

WST/RDD8 conversion

SMPTE2020 embed/de-embed

### Enhancement

#### Advanced Horizontal Enhancement

Frequency band selection (Low, Med, High)

3 preset enhancement levels (Soft 2, Soft 1, Normal, Sharp 1, Sharp 2)

Custom H Gain and H Noise rejection levels

#### Advanced Vertical Enhancement

Frequency band selection (Low, Med, High)

5 preset enhancement levels (Soft, Normal, Sharp 1, Sharp 2, Sharp 3)

#### Horizontal Aperture

5 preset H sharpness levels (Low 2, Low 1, Normal, High 1, High 2) 5 preset H detail levels

(Soft 2, Soft 1, Normal, Sharp 1, Sharp 2)

**Y/C alignment:** corrects for up-stream luma chroma displacement

### System

Pattern Off, Black, Ramp, Bars

Proc amp

**Black Level:** +100 to -100 mV (0) in 0.8 mV steps

**Contrast:** -6 dB to +6 dB (0) in 0.2 dB steps

**Saturation:** -6 dB to +6 dB (0) in 0.2 dB steps

**Y Gamma:** 0.4 to 1.7 (1) in 0.1 steps

**Freeze:** On/Off

**Genlock:** Reference lock, Input lock (same format), Follow input (same frame rate), Free run

**Memories:** 16 user memories

Legalizer

EDH support

### Communications

Remote control via web interface and RollCall network (IP)

### Power (Primary and Secondary)

**Input voltage range:** 100 – 240 VAC, 50/60 Hz 1.2A (max.) via three-pin IEC power socket

### Mechanical

**Temperature range:** 0 to 45° C (32° to 113° F) operating

**Cooling:** Internal fan, side venting

**Weight:** Approximately 3.2 kg

**Case type:** 1 RU, rack mounting

**Dimensions:** 44 x 430 x 400 mm (1.7 x 16.9 x 15.7 in.) (HxWxD)

**GPI:** 2 available

### Throughput Delay

#### Video processing delay:

**Field = 16.7 or 20ms**

**Frame = 33.3 or 40ms**

With scaling active in same frame rate:

Ref lock/Free run – Between 3 and 5 fields + ~200 μs

Input lock (SDI) – 3 fields + 1 ms

With same standard in & out and sync mode = Enabled:

Ref lock/Free run – Between ~200 μs and 1 frame + ~200 μs

Input lock (SDI) – ~1 ms

**Frame rate conversion:** any lock mode – 110 ms typical

#### Audio processing delay (Audio delay = 0ms)

With scaling active in same frame rate:

Ref lock/Free run – 1.5 frames

Input lock – 1 frame + 1 ms

With same standard in & out and sync mode = Enabled:

Ref lock/Free run – 0.5 frames

Input lock – ~3 ms

**Frame rate conversion:** any lock mode – 110 ms typical

## ORDERING

### 6143110

MC500-CT1 Single channel motion compensated frame rate converter and adaptive format converter.

Including frame synchronization, ARC control, noise reduction, side-bar keying, logo insertion, CC, WST and timecode handling, picture enhancement tools, 16-channel audio processing inc gain, delay & shuffling. SD, HD and 3Gbps SDI (BNC or fiber), CVBS, GPI, AES and analog audio I/O. HDMI monitor output & dual PSUs.



MC500 rear panel

# LC2000

## Motion Adaptive Standards Converter

The LC2000 is a highly cost-effective, linear motion adaptive standards converter.



### KEY FEATURES

- Linear motion adaptive SD/HD/3G high-density frame rate conversion
- SD/HD/3G up-, down- and crossconversion
- Independent dual channel conversion
- Flexible video and audio I/O configuration
- 16-channel embedded audio processing for each video channel
- Continuous output when input standard switches
- HDMI monitor output
- Dual PSU as standard
- Relay bypass on primary SDI inputs
- Automatic aspect ratio conversion (AFD, VI, L23)
- Powerful picture enhancement tools
- Front panel and remote control via web interface and RollCall
- Closed caption and timecode handling
- Synchronization
- User chosen line for SMPTE ST 2016
- GPI support
- Front panel control lock
- SMPTE ST 2020 metadata support
- Caption generator
- Logo inserter
- Sidebar keyer
- Clean cut
- Composite input/output
- Fiber input/output

### Applications

- High density international program distribution
- Low-cost frame rate conversion
- International TV and video back-up channels

### LC2000 Video Processing

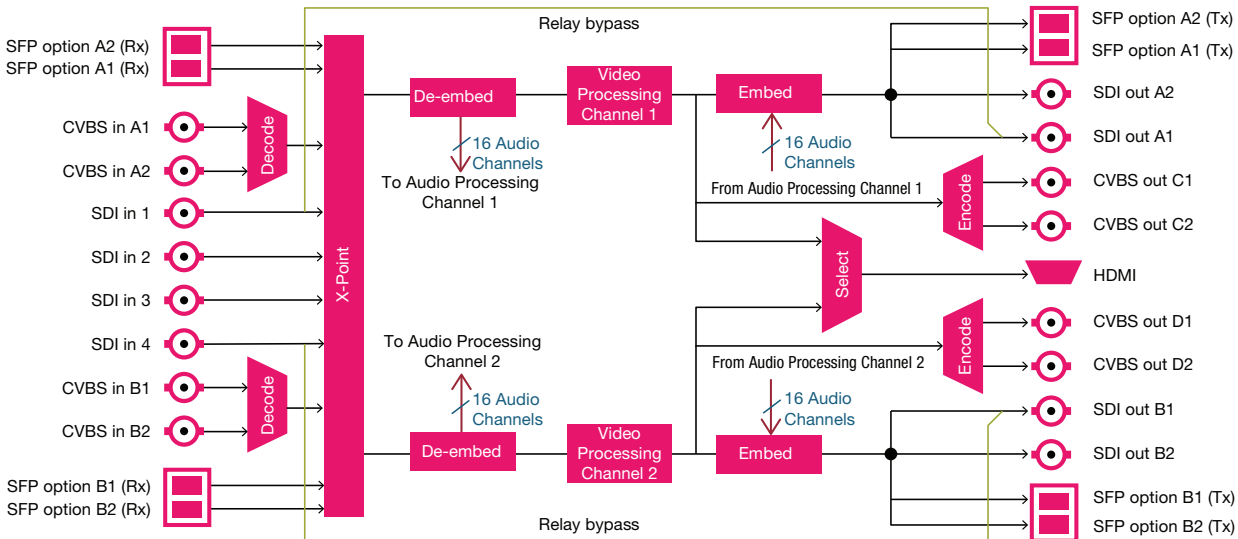

### LC2000 Audio Processing

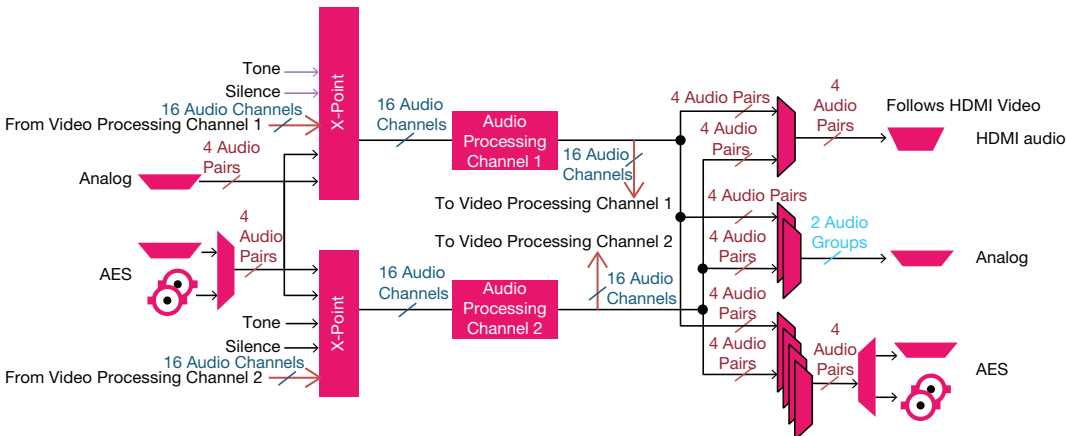

# KudosPro & KudosPro-IQ Single, Dual and Quad Channel Format and Frame Rate Conversion

## SPECIFICATIONS

### Signal Inputs

Serial digital 4x 75Ω SD/HD/3G serial digital with embedded audio

#### Input standards:

- 3 Gb/s SD-SDI, SMPTE ST 425 level A, level B
- 1.5 Gb/s HD-SDI SMPTE ST 292/SMPTE ST 299
- 270 Mb/s SD-SDI SMPTE ST 259

Composite PAL, NTSC, NTSC-J, PAL-M, PAL-N, N4.4, SECAM

12-bit ADCs

Analog component YC

**Reference:** 1 x loop-through HDTV Trisync/SD Bi-sync (black & burst) SMPTE ST 240/SMPTE ST 274

#### Audio AES:

- 4x balanced AES inputs – via 25-way D-Type
- 4x unbalanced AES inputs – via 4x BNC

**Audio analog:** 4x stereo analog inputs via 25-way D-Type

### Signal Outputs

Serial digital 4 x 75Ω SD/HD/3G serial digital with embedded audio

#### Output standards:

- 3 Gb/s HD-SDI, SMPTE ST 425 level A, level B
- 1.5 Gb/s HD-SDI SMPTE ST 292/SMPTE ST 299
- 270 Mb/s SD-SDI SMPTE ST 259

Composite PAL, NTSC, NTSC-J, PAL-M, PAL-N

12-bit DACs

Analog component YC

#### Audio AES:

- 4x balanced AES outputs – via 25-way D-Type
- 4x unbalanced AES outputs – via 4x BNC

**Audio analog:** 2x stereo analog outputs via 25-way D Type

### Input Standards

(auto detect) 525, 625

720 50/59.94/60p

1080 50/59.94/60i

1080 50/59.94/60p (Levels A and B)

720/1080 23/24/25/29/30p

1080 23/24/25/29psf

### Output Standards

525, 625

720 50/59.94/60p

1080 50/59.94/60i

1080 50/59.94/60p (Levels A and B)

720/1080 23/24/25/29/30p

1080 23/24/25/29psf

### Conversion Functions

**Modes:** SD/HD/3G Linear Standards

**Conversion:** Upconversion, Downconversion, Crossconversion

### Manual or Automatic ARC

AFD (SMPTE ST 2016), VI (RP186), WSS (L23)

**SD input format:** Normal 4:3, Anamorphic 16:9, Letterbox 14:9, Letterbox 16:9

**SD output format:** Normal 4:3, Anamorphic 16:9, Letterbox 14:9, Letterbox 16:9

**Auto zoom:** On/Off

**Manual zoom:** Zoom  $\pm 20\%$

**Safe area marker:** Off, 16:9, 4:3

**Manual controls:** size, aspect, pan, tilt

Wide range of ARC presets including 702 sample line mode

### Audio Functions

#### Analog Audio:

Four pairs of analogue inputs are individually available to any or all processing channels

Two groups (2 pairs) of analog output are separately assignable to any processing channel

Headroom +24 dBu; balanced connection

#### AES Audio:

Four AES audio inputs are individually available to any or all processing channels

Four AES audio outputs (48 kHz) are separately assignable to any processing channel  
AES input is auto-detected as PCM (32-96 kHz) or non-PCM (48 kHz locked to relevant video input)

#### Embedded Audio:

Each processing channel includes 16-channel embedded audio processing

PCM audio processing includes channel level gain and delay compensation, as well as channel level routing/shuffle with audio phase inversion

Non-PCM processing features pair level routing and delay compensation

Dolby-E data is passed with a delay to match the video and with co-timed audio frame drop or repeat

### Metadata

Closed caption CEA608 <> CEA708

Timecode conversions

WST/RDD8 conversion

SMPTE ST 2020 embed/de-embed

### Enhancement

#### Advanced Horizontal Enhancement:

Frequency band selection (Low, Med, High)

4 preset enhancement levels (Low, Med, High, Super)

Custom H Gain and H Noise rejection levels

#### Advanced Vertical Enhancement:

Frequency band selection (Low, Med, High)

5 preset enhancement levels (Soft 2, Soft 1, Normal, Sharp 1, Sharp 2)

#### Horizontal Aperture:

5 preset H sharpness levels (Low 2, Low 1, Normal, High 1, High 2)

5 preset H detail levels (Soft 2, Soft 1, Normal, Sharp 1, Sharp 2)

#### Noise reduction: spatial, recursive

**Y/C alignment:** corrects for up-stream luma-chroma displacement

### System

Pattern Off, Black, Ramp, Bars

Proc amp

**Black Level:** +100 to -100 mV (0) in 0.8 mV steps

**Contrast:** -6 dB to +6 dB (0) in 0.2 dB steps

**Saturation:** -6 dB to +6 dB (0) in 0.2 dB steps

**Y Gamma:** 0.4 to 1.7 (1) in 0.1 steps

Freeze On/Off

**Genlock:** Reference lock, Input lock (same format), Follow input (same frame rate), Free run

**Memories:** 16 user memories

Legalizer

EDH support

### Communications

Remote control via web interface and RollCall network (IP)

### Power (Primary and Secondary)

Input voltage range 100 – 240 VAC, 50/60 Hz 1.5A (max.) via three-pin IEC power socket

### Mechanical

**Temperature range:** 0 to 45° C (32° to 113° F) operating

**Cooling:** Internal fan, side venting

**Weight:** Approximately 4.25 kg (9.4 lbs.)

**Case type:** 1 RU, rack mounting

**Dimensions:** 44 x 430 x 400 mm (1.7 x 16.9 x 15.7 in.) (HxWxD)

Headphones socket with volume control

**GPIO:** 8 available

### Throughput Delay

#### Video processing delay:

**Field = 16.7 or 20 ms**

**Frame = 33.3 or 40 ms**

With scaling active in same frame rate:

Ref lock/Free run – between 3 and 5 fields + ~200  $\mu$ s

Input lock (SDI) – 3 fields + 1 ms

With same standard in & out and Sync mode = Enabled:

Ref lock/Free run – between ~200  $\mu$ s and 1 frame + ~200  $\mu$ s

Input lock (SDI) – ~1 ms

Frame rate conversion:

Any lock mode – 110 ms typical

#### Audio processing delay (Audio delay = 0 ms):

With scaling active in same frame rate:

Ref lock/Free run – 1.5 frames

Input lock – 1 frame + 1 ms

With same standard in & out and sync mode = Enabled:

Ref lock/Free run – 0.5 frames

Input lock – ~3 ms

Frame rate conversion:

Any lock mode – 110 ms typical

## ORDERING

### 6122110

LC2000-CT2 Dual channel video & audio processing unit, including frame rate/format conversion, frame synchronization, ARC control, noise reduction, side-bar keying, logo insertion, CC, WST and timecode handling, picture enhancement tools, 16 channel audio processing inc gain, delay & shuffling. SDI (BNC or fiber), CVBS, GPI, AES and analog audio I/O. HDMI monitor output & dual PSUs.



Rear panel shows LC4000 with CVBS option fitted.

# UHD1200

## 12G UHD Video & Audio Processor

UHD1200 is a flexible 12G or quad-link 4K UHD processing unit including high dynamic range and wide color gamut mapping along with converting to or from 4K UHD and 3G/HD/SD. Such advanced processing allows re-purposing of existing or new assets, as well as covering all common video and audio processing tasks.



### KEY FEATURES

- SD/HD/3G/4K UHD up-, down- and crossconversion with clean cut feature
- Frame Synchronization including continuous output on input standard changes
- HDR (PQ, HLG, S-Log3) and BT2020 wide color gamut support, along with video proc and powerful picture enhancement tools, including edge enhance and noise reduction
- 16-channel embedded audio processing and PCM/Dolby audio delay compensation
- Metadata support including closed caption, WST, timecode and SMPTE ST 2020 handling
- Easy to use control options inc. front panel with control lock, and remote via web interface and RollCall
- Linear motion adaptive frame rate conversion available when up or down converting
- Automatic aspect ratio conversion with signaling support (SMPTE ST 2016, L23 ETSI, L23 AFD, VI SMPTE, VI AFD)

- Balanced AES and analog audio I/O
- Support for fiber Tx and Rx via SFP
- Dual PSU as standard

### Applications

- Repurpose existing HD content — upconvert for distribution over 4K UHD channels
- Service existing HD channels — downconvert 4K UHD content for simulcast on mainstream HD services
- Integrate HDR (PQ, HLG, S-Log3) signals into SDR workflows, translate between HDR standards, or map SDR signals for use in HDR productions
- Cover color space requirements with BT709 and BT2020 translation features
- 4K UHD signal processing — synchronize, adjust and enhance, or process audio with UHD1200s comprehensive control features

### UHD1200 Processing

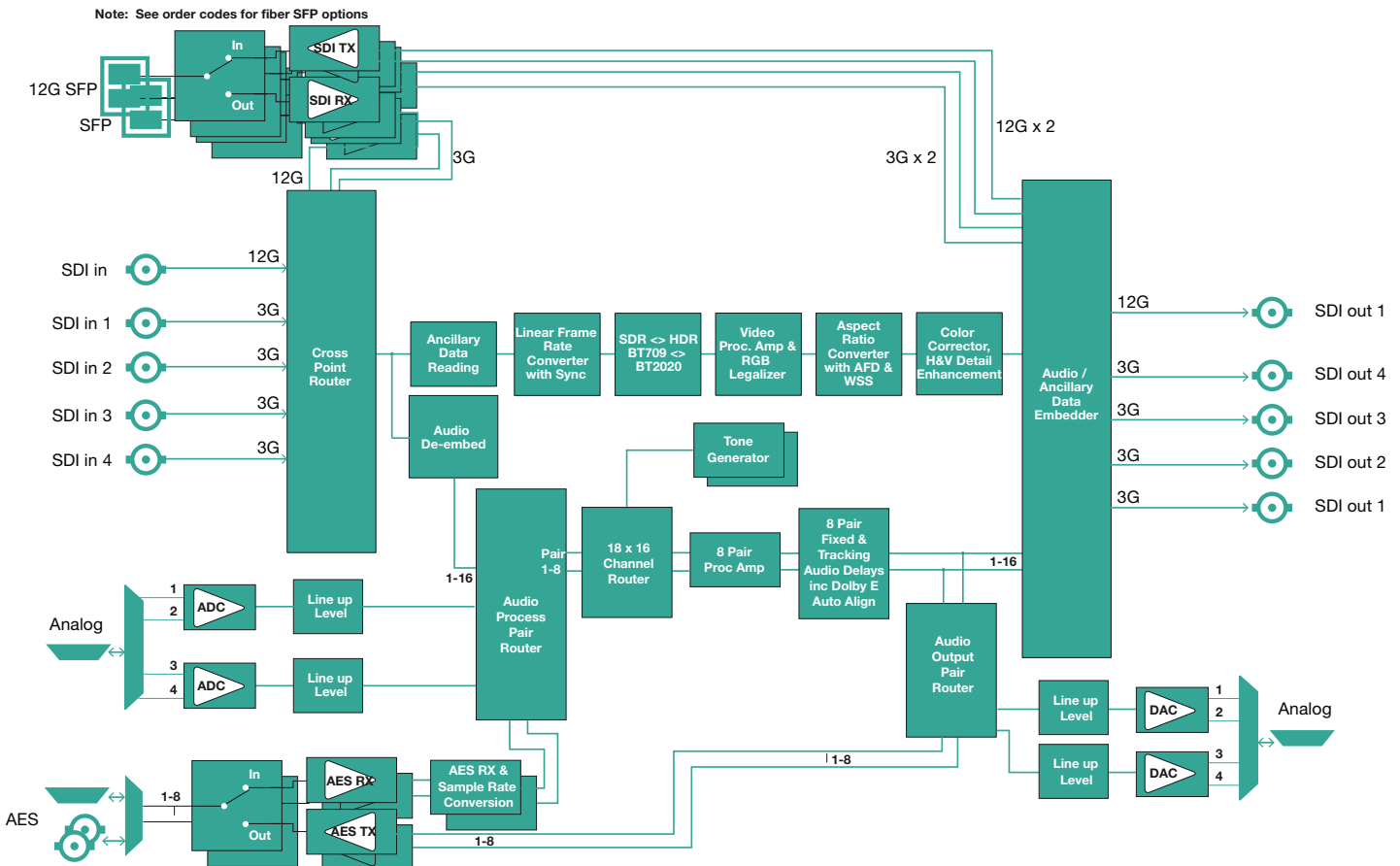



# KudosPro & KudosPro-IQ Single, Dual and Quad Channel Format and Frame Rate Conversion

## SPECIFICATIONS

### Signal Inputs

Serial digital 1x 75Ω SD/HD/3G/12Gb/s/4K UHD-1 serial digital with embedded audio

Serial digital 4x 75Ω SD/HD/3G/4K UHD-1 serial digital with embedded audio

### Input standards:

12 Gb/s 4K UHD-1 single link to SMPTE ST 2082

4K UHD-1 Quad-link-SDI, SMPTE ST 203

3 Gb/s HD-SDI, SMPTE ST 425 level A, dual-link level B

1.5 Gb/s HD-SDI SMPTE ST 292/SMPTE ST 299

270 Mb/s SD-SDI SMPTE ST 259

**Reference:** 1x loop-through HDTV Trisync/SD Bi-sync (black & burst) SMPTE ST 240/SMPTE ST 274

**Audio AES (option):** up to 8x balanced AES inputs – via 25-way D-Type

**Analog audio (option):** 2x stereo analog inputs via 25-way D-Type

### Signal Outputs

Serial digital 1x 75Ω SD/HD/3G/12Gb/s/4K UHD-1 serial digital with embedded audio

Serial digital 4x 75Ω SD/HD/3G/s/4K UHD-1 serial digital with embedded audio

### Output standards:

12 Gb/s 4K UHD-1 single link to SMPTE ST 2082

4K UHD-1 Quad-link, SMPTE ST 2036

3 Gb/s HD-SDI, SMPTE ST 425 level A, dual-link level B

1.5 Gb/s HD-SDI SMPTE ST 292/SMPTE ST 299

270 Mb/s SD-SDI SMPTE ST 259

**Audio AES (option):** up to 8x balanced AES outputs – via 25-way D-Type

**Analog audio (option):** 2x stereo analog outputs via 25-way D-Type

### Input Standards

(auto detect) 525, 625

720 50/59.94/60p

1080 50/59.94/60i

1080 50/59.94/60p (Levels A and B)

720/1080/2160 23/24/25/29.97/30p

1080 23/24/25/29.97/30psf, with film detection and processing

2160 50/59.94/60p (Levels A and B)

### Output Standards

525, 625

720 50/59.94/60p

1080 50/59.94/60i

1080 50/59.94/60p (Levels A and B)

720/1080/2160 23/24/25/29.97/30p

1080 23/24/25/29.97psf, with film detection and processing

2160 50/59.94/60p (Levels A and B)

### Video Functions

Upconversion, Downconversion, Crossconversion

Square division to/from 2SI conversion

SD/HD/3G to/from 4K UHD-1 Linear Standards Conversion

Noise Reduction

SDR to/from HDR (PQ, HLG, S-Log3)

Color space BT709 to/from BT2020

### Manual or Automatic ARC

AFD (SMPTE 2016), VI (RP186), WSS (L23)

SD input format: Normal 4:3, Anamorphic

16:9, Letterbox 14:9, Letterbox 16:9

SD output format: Normal 4:3, Anamorphic

16:9, Letterbox 14:9, Letterbox 16:9

Auto zoom: On/Off

Manual zoom: Zoom ±20%

Safe area marker: Off, 16:9, 4:3

Manual controls: size, aspect, pan, tilt

Wide range of ARC presets including 702 sample line mode

### Metadata

Closed caption CEA608 <> CEA708

Timecode conversions

WST/RDD8 conversion

SMPTE ST 2020 embed/de-embed

### Audio Functions

#### Analog Audio (option):

Two pairs of analog inputs are individually available to the processing channel

Headroom +24 dBu; balanced connection

#### AES Audio (option):

AES audio is accessible via 8 bidirectional ports which can be configured as inputs or outputs

AES input is auto-detected as PCM (32-96 kHz) or non-PCM (48 kHz locked to relevant video input)

#### Embedded Audio:

16-channel embedded audio processing

PCM audio processing includes channel level gain and delay compensation, as well as channel level routing/shuffle with audio phase inversion

Non-PCM processing features pair level routing and delay compensation

### System

Pattern Off, Black, Ramp, Bars

Proc amp

**Black Level:** +100 to -100 mV (0) in 0.8 mV steps

**Contrast:** -6 dB to +6 dB (0) in 0.2 dB steps

**Saturation:** -6 dB to +6 dB (0) in 0.2 dB steps

**Y Gamma:** 0.4 to 1.7 (1) in 0.1 steps

**Freeze:** On/Off

**Genlock:** Reference lock, Input lock (same format), Follow input (same frame rate), Free run

**Memories:** 16 user memories

Adjustable Legalizer

EDH support

### Communications

Remote control via web interface and RollCall network (IP)

### Power (Primary and Secondary)

**Input voltage range:** 100 – 240 VAC, 50/60 Hz 1.5A (max.) via three-pin IEC power socket

### Mechanical

**Temperature range:** 0 to 45° C (32° to 113° F) operating

**Cooling:** Internal fan, side venting

**Weight:** Approximately 4.25 kg (9.4 lbs.)

**Case type:** 1 RU, rack mounting

**Dimensions:** 44 x 430 x 400 mm (1.7 x 16.9 x 15.7 in.) (HxWxD)

## ORDERING

**6111121** UHD1200 Single-channel 4K UHD-1 video & audio processing unit with 12G SDI (BNC or fiber), remote or front panel control and Dual PSUs.

**6111131** UHD1200 Single-channel 4K UHD-1 video & audio processing unit with 12G SDI (BNC or fiber), AES and analog audio I/O, remote or front panel control and Dual PSUs.

### SFP Option 1/2

#### FC1-R2

Fiber SFP module — 2x Fiber Rx

#### FC1-HDBR2

HD-BNC SFP module — 2x Rx HD-BNC

#### FC1-13T2

Fiber SFP module — 2x Fiber Tx

#### FC1-HDBT2

HD-BNC SFP module — 2x Tx HD-BNC

### SFP Option 3/4

#### FC1-R2-12G

Fiber SFP module — 2x 12G Fiber Rx

#### FC1-HDBR2-12

HD-BNC SFP module — 2x Rx HD-BNC — 12G

#### FC1-13T2-12G

Fiber SFP module — 2x 12G Fiber Tx

#### FC1-HDBT2-12

HD-BNC SFP module — 2x Tx HD-BNC — 12G



# UHD1100

## 4K UHD-1 Video & Audio Processor

UHD1100 is a flexible 4K UHD-1 processing unit able to process and translate both quadrant (square division) and 2SI (2 sample interleave) quad-link formats. Converting to or from 4K UHD to 3G/HD/SD allows repurposing of existing assets, and all common video and audio processing tasks are also covered.



### KEY FEATURES

- Frame synchronization including continuous output on input standard changes
- SD/HD/3G/4K UHD up-, down- and crossconversion with clean cut feature
- HDR (PQ, HLG, S-Log3) and BT2020 wide color gamut support, along with video proc and powerful picture enhancement tools, including edge enhance and noise reduction
- 16-channel embedded audio processing and PCM/Dolby audio delay compensation
- Metadata support including closed caption, WST, timecode and SMPTE ST 2020 handling
- Easy to use control options including front panel with control lock, and remote via web interface and RollCall
- Linear motion adaptive frame rate conversion available when up- or downconverting
- Automatic aspect ratio conversion with signaling support (SMPTE ST 2016, L23 ETSI, L23 AFD, VI SMPTE, VI AFD)

- Balanced AES and analog audio I/O
- Support for fiber Tx and Rx via SFP
- Dual PSU as standard

### Applications

- Repurpose existing HD content — up convert for distribution over 4K UHD channels
- Service existing HD channels — down convert 4K UHD content for simulcast on mainstream HD services
- Integrate HDR (PQ, HLG, S-Log3) signals into SDR workflows, translate between HDR standards, or map SDR signals for use in HDR productions
- Cover color space requirements with BT709 and BT2020 translation features
- 4K UHD signal processing — synchronize, adjust and enhance, or process audio with UHD1100's comprehensive control features

### UHD1100 Processing

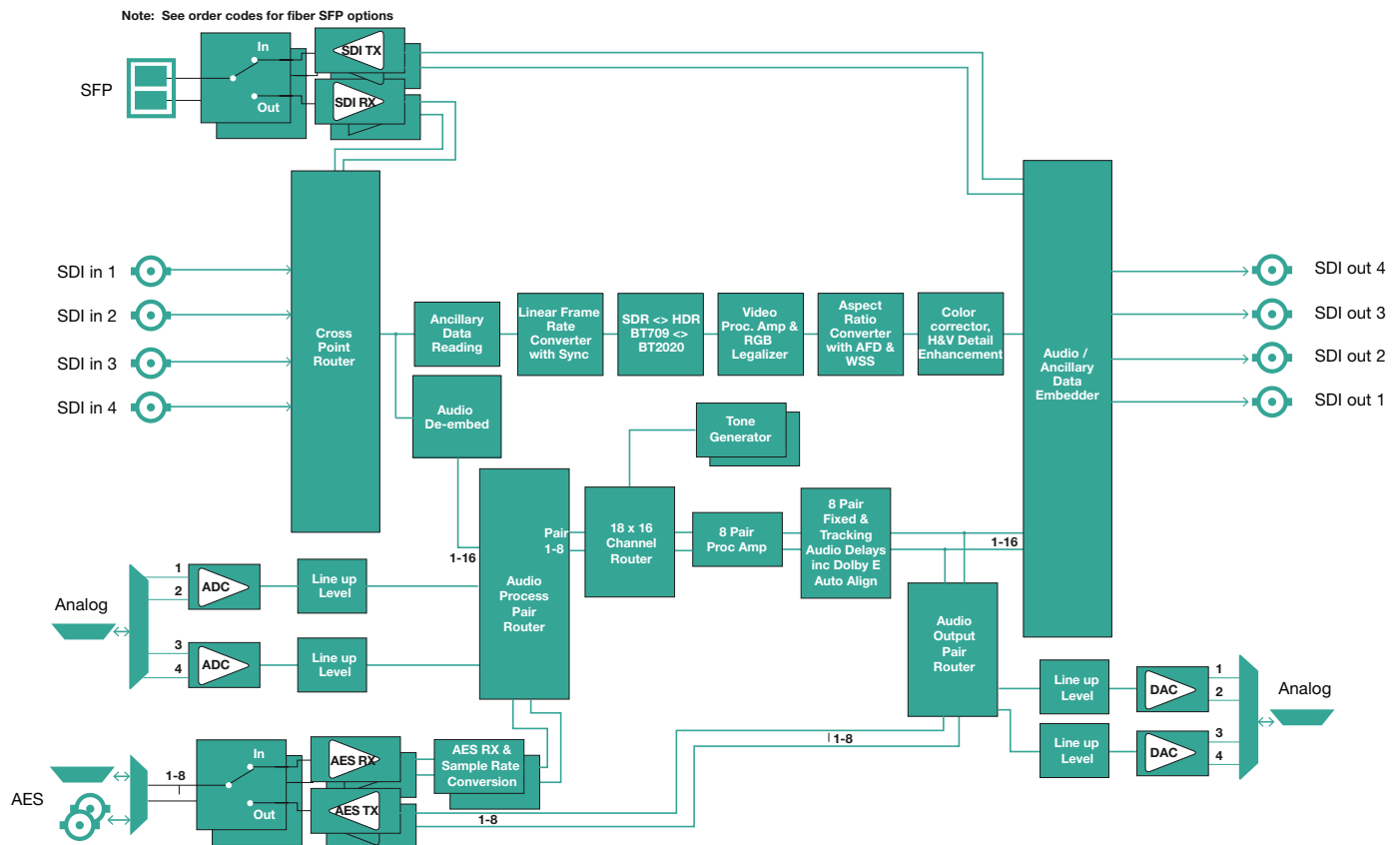

# KudosPro & KudosPro-IQ Single, Dual and Quad Channel Format and Frame Rate Conversion

## SPECIFICATIONS

### Signal Inputs

Serial digital 4x 75Ω SD/HD/3G/4K UHD-1 serial digital with embedded audio

### Input standards:

- 4K UHD-1 Quad-link-SDI, SMPTE ST 2036
- 3 Gb/s HD-SDI, SMPTE ST 425 level A, dual-link level B
- 1.5 Gb/s HD-SDI SMPTE ST 292/SMPTE ST 299
- 270 Mb/s SD-SDI SMPTE ST 259

**Reference:** 1x loop-through HDTV Trisync/SD Bi-sync (black & burst) SMPTE ST 240/SMPTE ST 274

**Audio AES (option):** up to 8x balanced AES inputs – via 25-way D-Type

**Analog audio (option):** 2x stereo analog inputs via 25-way D-Type

### Signal Outputs

Serial digital 4x 75Ω SD/HD/3G/4K UHD-1 serial digital with embedded audio

### Output standards:

- 4K UHD-1 Quad-link, SMPTE ST 2036
- 3 Gb/s HD-SDI, SMPTE ST 425 level A, dual-link level B
- 1.5 Gb/s HD-SDI SMPTE ST 292/SMPTE ST 299M
- 270 Mb/s SD-SDI SMPTE ST 259

**Audio AES (option):** up to 8x balanced AES outputs – via 25-way D-Type

**Analog audio (option):** 2x stereo analog outputs via 25-way D-Type

### Input Standards

(auto detect) 525, 625  
720 50/59.94/60p  
1080 50/59.94/60i  
1080 50/59.94/60p (Levels A and B)

720/1080/2160 23/24/25/29.97/30p  
1080 23/24/25/29.97/30psf, with film detection and processing  
2160 50/59.94/60p (Levels A and B)

### Output Standards

525, 625  
720 50/59.94/60p  
1080 50/59.94/60i  
1080 50/59.94/60p (Levels A and B)  
720/1080/2160 23/24/25/29.97/30p  
1080 23/24/25/29.97psf, with film detection and processing  
2160 50/59.94/60p (Levels A and B)

### Video Functions

Upconversion, Downconversion, Crossconversion  
Square division to/from 2SI conversion  
SD/HD/3G to/from 4K UHD-1 Linear Standards Conversion  
Noise Reduction  
SDR to/from HDR (PQ, HLG, S-Log3)  
Color space BT709 to/from BT2020

### Manual or Automatic ARC

AFD (SMPTE 2016), VI (RP186), WSS (L23)  
SD input format: Normal 4:3, Anamorphic 16:9, Letterbox 14:9, Letterbox 16:9  
SD output format: Normal 4:3, Anamorphic 16:9, Letterbox 14:9, Letterbox 16:9  
Auto zoom: On/Off  
Manual zoom: Zoom ±20%  
Safe area marker: Off, 16:9, 4:3  
Manual controls: size, aspect, pan, tilt  
Wide range of ARC presets including 702 sample line mode

### Metadata

Closed caption CEA608 <> CEA708

Timecode conversions  
WST/RDD8 conversion  
SMPTE ST 2020 embed/de-embed

### Audio Functions

#### Analog Audio (option):

Two pairs of analog inputs are individually available to the processing channel  
Headroom +24 dBu; balanced connection

#### AES Audio (option):

AES audio is accessible via 8 bidirectional ports which can be configured as inputs or outputs  
AES input is auto-detected as PCM (32-96 kHz) or non-PCM (48 kHz locked to relevant video input)

#### Embedded Audio:

16-channel embedded audio processing  
PCM audio processing includes channel level gain and delay compensation, as well as channel level routing/shuffle with audio phase inversion  
Non-PCM processing features pair level routing and delay compensation  
Dolby-E data is passed with a delay to match the video and with co-timed audio frame drop or repeat.

### System

Pattern Off, Black, Ramp, Bars

Proc amp

**Black Level:** +100 to -100 mV (0) in 0.8 mV steps

**Contrast:** -6 dB to +6 dB (0) in 0.2 dB steps

**Saturation:** -6 dB to +6 dB (0) in 0.2 dB steps

**Y Gamma:** 0.4 to 1.7 (1) in 0.1 steps

Freeze On/Off

**Genlock:** Reference lock, Input lock (same format), Follow input (same frame rate), Free run

**Memories:** 16 user memories

Adjustable Legalizer

EDH support

### Communications

Remote control via web interface and RollCall network (IP)

### Power (Primary and Secondary)

**Input voltage range:** 100 – 240 VAC, 50/60 Hz 1.5A (max.) via three-pin IEC power socket

### Mechanical

**Temperature range:** 0 to 45° C (32° to 113° F) operating

**Cooling:** Internal fan, side venting

**Weight:** Approximately 4.25 kg (9.4 lbs.)

**Case type:** 1 RU, rack mounting

**Dimensions:** 44 x 430 x 400 mm (1.7 x 16.9 x 15.7 in.) (HxWxD)

## ORDERING

- 6111141** UHD1100 Single-channel 4K UHD-1 video & audio processing unit with SDI (BNC or Fiber), remote or front panel control and Dual PSUs.
- 6111151** UHD1100 Single channel 4K UHD-1 video & audio processing unit with SDI (BNC or Fiber), AES and analog audio I/O, remote or front panel control and Dual PSUs.

### SFP Option 1/2

#### FC1-R2

Fiber SFP module — 2x Fiber Rx

#### FC1-HDBR2

HD-BNC SFP module — 2x Rx HD-BNC

#### FC1-13T2

Fiber SFP module — 2x Fiber Tx

#### FC1-HDBT2

HD-BNC SFP module — 2x Tx HD-BNC



# SV2000 and SV4000

## Up/Down/Crossconverters

SV2000 and SV4000 are low-cost, high-density up-, down-, and crossconverters.



### KEY FEATURES

- SD/HD/3G up-, down- and crossconversion
  - Independent dual channel (SV2000) and quad channel conversion (SV4000)
  - Frame synchronization
  - Flexible video and audio I/O configuration 16-channel embedded audio processing for each video channel
  - Continuous output when input standard switches
  - HDMI monitor output
  - Dual PSU as standard
  - Relay bypass on primary SDI inputs
  - Automatic aspect ratio conversion (AFD, VI, L23)
  - Powerful picture enhancement tools
  - User friendly front panel as well as remote control via web interface and RollCall
  - Closed caption and timecode handling
  - User chosen line for SMPTE ST 2016
  - GPI support
  - Front panel control lock
  - SMPTE ST 2020 metadata support
  - Caption generator
  - Logo inserter
  - Sidebar keyer
  - Clean cut
  - Composite input/output
- Optional Features**
- Fiber input/output
- Applications**
- Integration of SD programming into HD schedules
  - Supporting legacy SD channels with HD produced content
  - Future-proofing investments up to 1080p 3 Gb/s

### SV2000 Video Processing

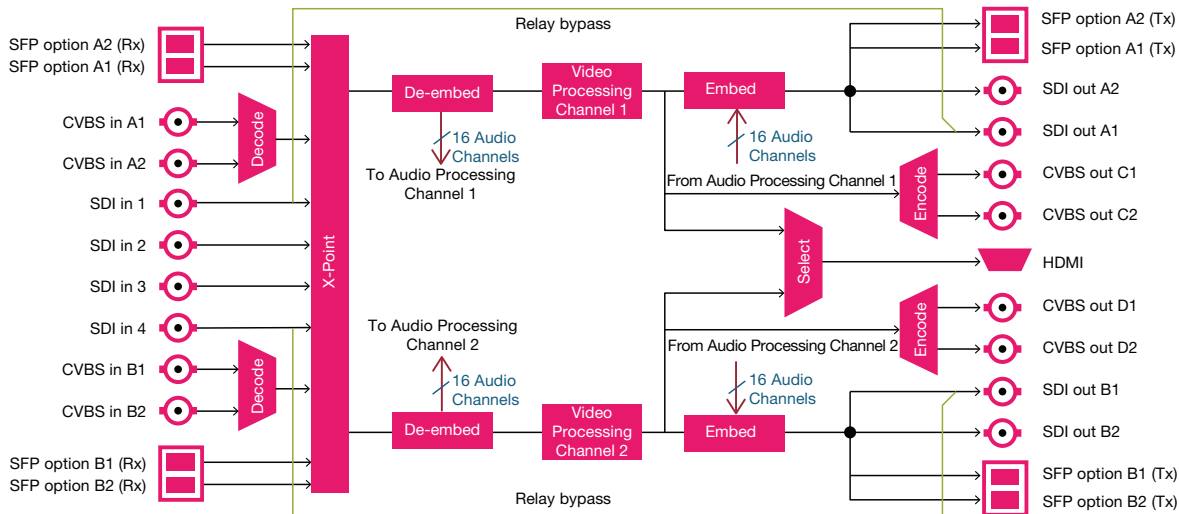

### SV2000 Audio Processing

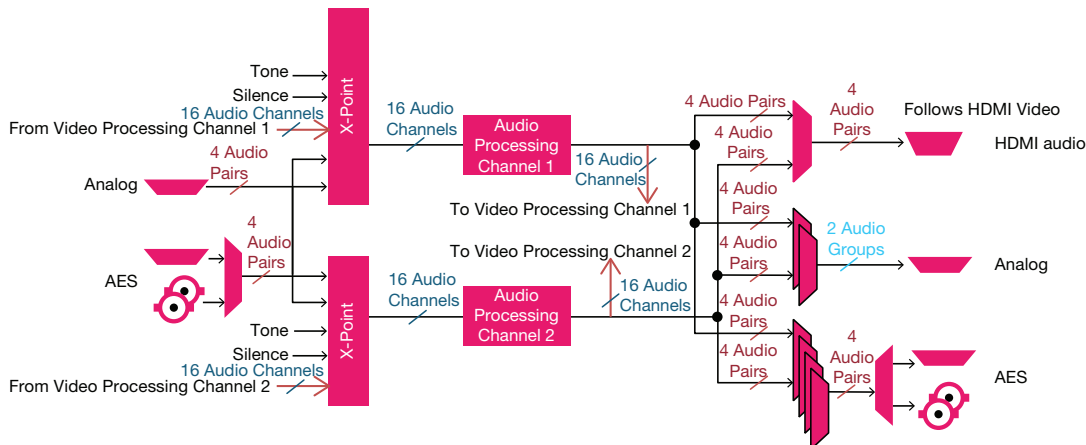



SV4000 Video Processing

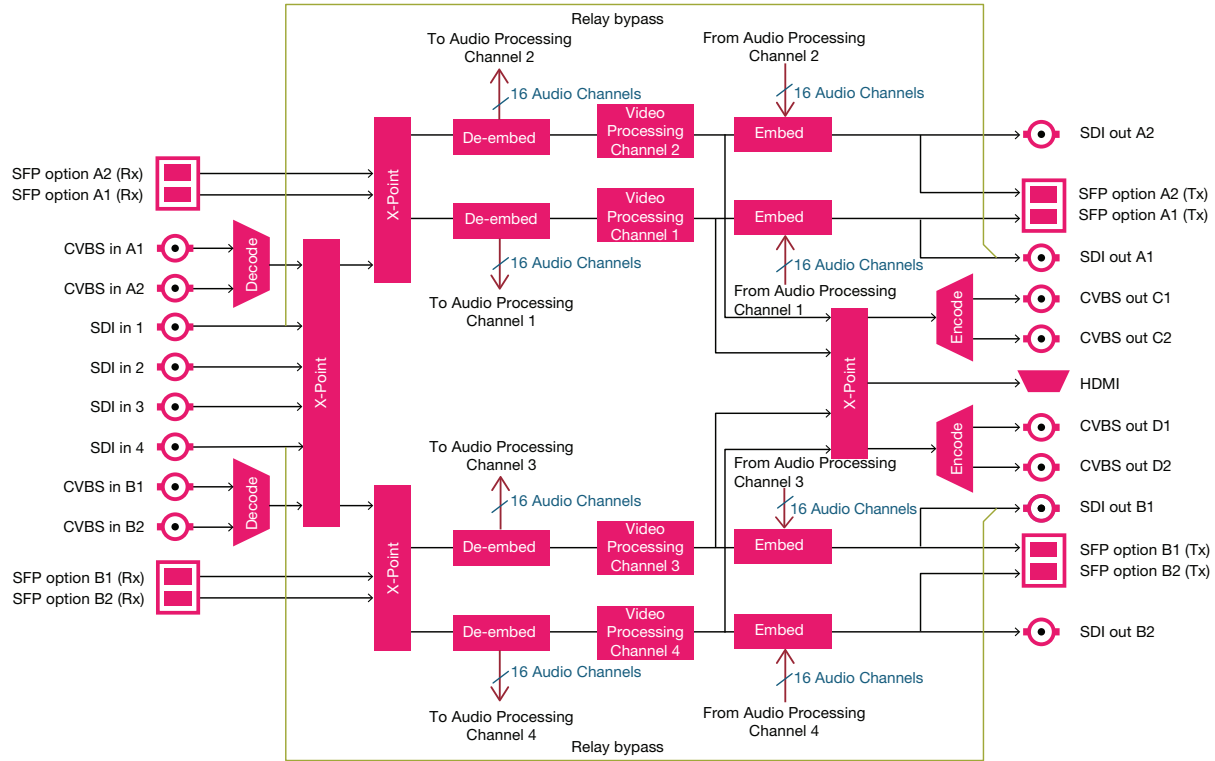

SV4000 Audio Processing

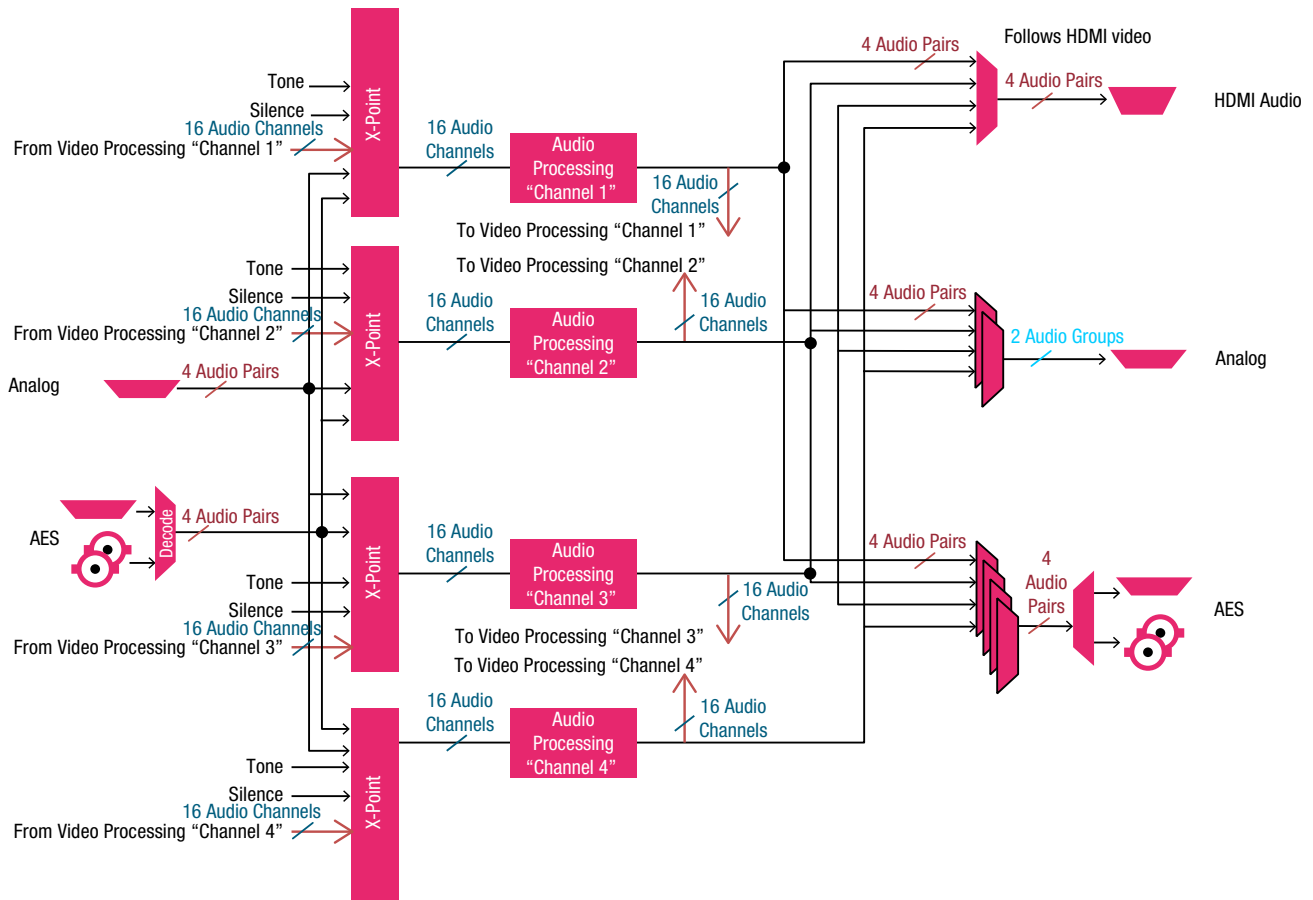

## SPECIFICATIONS

### Signal Inputs

Serial digital 4x 75Ω SD/HD/3G serial digital with embedded audio

#### Input standards:

- 3 Gb/s SD-SDI, SMPTE ST 425 level A, level B
- 1.5 Gb/s HD-SDI SMPTE ST 292/SMPTE ST 299
- 270 Mb/s SD-SDI SMPTE ST 259

Composite PAL, NTSC, NTSC-J, PAL-M, PAL-N, N4.4, SECAM

12-bit ADCs

Analog component YC

**Reference:** 1x loop-through HDTV Trisync/SD Bi-sync (black & burst) SMPTE ST 240/SMPTE ST 274

#### Audio AES:

- 4x balanced AES inputs – via 25-way D-Type
- 4x unbalanced AES inputs – via 4x BNC

**Audio analog:** 4x stereo analog inputs via 25-way D-Type

### Signal Outputs

Serial digital 4x 75Ω SD/HD/3G serial digital with embedded audio

#### Output standards:

- 3 Gb/s HD-SDI, SMPTE ST 425 level A, level B
- 1.5 Gb/s HD-SDI SMPTE ST 292/SMPTE ST 299
- 270 Mb/s SD-SDI SMPTE ST 259

Composite PAL, NTSC, NTSC-J, PAL-M, PAL-N

12-bit DACs

Analog component YC

#### Audio AES:

- 4x balanced AES outputs – via 25-way D-Type
- 4x unbalanced AES outputs – via 4x BNC

**Audio analog:** 2x stereo analog outputs via 25-way D-Type

### Input Standards

(auto detect) 525, 625

720 50/59.94/60p

1080 50/59.94/60i

1080 50/59.94/60p (Levels A and B)

720/1080 23/24/25/29/30p

1080 23/24/25/29psf

### Output Standard

525, 625

720 50/59.94/60p

1080 50/59.94/60i

1080 50/59.94/60p (Levels A and B)

720/1080 23/24/25/29/30p

1080 23/24/25/29psf

### Conversion Functions

**Modes:** SD/HD/3G Upconversion, Downconversion, Crossconversion at the same frame rate

### Manual or Automatic ARC

AFD (SMPTE ST 2016), VI (RP186), WSS (L23)

**SD input format:** Normal 4:3, Anamorphic 16:9, Letterbox 14:9, Letterbox 16:9

**SD output format:** Normal 4:3, Anamorphic 16:9, Letterbox 14:9, Letterbox 16:9

**Auto zoom:** On/Off

**Manual zoom:** Zoom ±20%

**Safe area marker:** Off, 16:9, 4:3

**Manual controls:** size, aspect, pan, tilt

Wide range of ARC presets including 702 sample line mode

### Audio Functions

#### Analog Audio:

Four pairs of analog inputs are individually available to any or all processing channels

Two groups (2 pairs) of analog output are separately assignable to any processing channel

Headroom +24 dBu; balanced connection

#### AES Audio:

Four AES audio inputs are individually available to any or all processing channels

Four AES audio outputs (48 kHz) are separately assignable to any processing channel  
AES input is auto-detected as PCM (32-96 kHz) or non-PCM (48kHz locked to relevant video input)

#### Embedded Audio:

Each processing channel includes 16-channel embedded audio processing

PCM audio processing includes channel level gain and delay compensation, as well as channel level routing/shuffle with audio phase inversion

Non-PCM processing features pair level routing and delay compensation

Dolby-E data is passed with a delay to match the video and with co-timed audio frame drop or repeat

### Metadata

Closed caption CEA608 <> CEA708

Timecode conversions

WST/RDD8 conversion

SMPTE ST 2020 embed/de-embed

### Enhancement

#### Advanced Horizontal Enhancement:

Frequency band selection (Low, Med, High)

4 preset enhancement levels (Low, Med, High, Super)

Custom H Gain and H Noise rejection levels

#### Advanced Vertical Enhancement:

Frequency band selection (Low, Med, High)

5 preset enhancement levels (Soft 2, Soft 1, Normal, Sharp 1, Sharp 2)

#### Horizontal Aperture:

5 preset H sharpness levels (Low 2, Low 1, Normal, High 1, High 2)

5 preset H detail levels (Soft 2, Soft 1, Normal, Sharp 1, Sharp 2)

#### Noise reduction: spatial, recursive

**Y/C alignment:** corrects for up-stream lum chroma displacement

### System

Pattern Off, Black, Ramp, Bars

Proc amp

**Black Level:** +100 to -100 mV (0) in 0.8 mV steps

**Contrast:** -6 dB to +6 dB (0) in 0.2 dB steps

**Saturation:** -6 dB to +6 dB (0) in 0.2 dB steps

**Y Gamma:** 0.4 to 1.7 (1) in 0.1 steps

**Freeze:** On/Off

**Genlock:** Reference lock, Input lock (same format), Follow input (same frame rate), Free run

**Memories:** 16 user memories

Legalizer

EDH support

### Communications

Remote control via web interface and RollCall network (IP)

### Power (Primary and Secondary)

**Input voltage range:** 100 – 240 VAC, 50/60 Hz 1.5A (max.) via three-pin IEC power socket

### Mechanical

**Temperature range:** 0 to 45° C (32° to 113° F) operating

**Cooling:** Internal fan, side venting

**Weight:** Approximately 4.25 kg (9.4 lbs.)

**Case type:** 1 RU, rack mounting

**Dimensions:** 44 x 430 x 400 mm (1.7 x 16.9 x 15.7 in.) (HxWxD)

Headphones socket with volume control

**GPIO:** 8 available

### Throughput Delay

#### Video processing delay:

**Field = 16.7 or 20 ms**

**Frame = 33.3 or 40 ms**

With scaling active in same frame rate:

Ref lock/Free run – Between 3 and 5 fields + ~200 μs

Input lock (SDI) – 3 fields + 1 ms

With same standard in & out and sync mode = Enabled:

Ref lock/Free run – Between ~200 μs and 1 frame + ~200 μs

Input lock (SDI) – ~1 ms

Frame rate conversion: Any lock mode – 110 ms typical

#### Audio processing delay: (Audio delay = 0 ms)

With scaling active in same frame rate:

Ref lock/Free run – 1.5 frames

Input lock – 1 frame + 1 ms

With same standard in & out and sync mode = Enabled:

Ref lock Free run – 0.5 frames

Input lock – ~3 ms

Frame rate conversion: Any lock mode – 110 ms typical

## ORDERING

### 6112110

SV2000-CT2 Dual channel video & audio processing unit, including format conversion, frame synchronization, ARC control, noise reduction, side-bar keying, logo insertion, CC, WST and timecode handling, picture enhancement tools, 16-channel audio processing inc gain, delay & shuffling. SDI (BNC or fiber), CVBS, GPI, AES and analog audio I/O. HDMI monitor output & dual PSUs.

### 6114110

SV4000-CT2 Quad channel video & audio processing unit, including format conversion, frame synchronization, ARC control, noise reduction, side-bar keying, logo insertion, CC, WST and timecode handling, picture enhancement tools, 16-channel audio processing inc gain, delay & shuffling. SDI (BNC or fiber), CVBS for 2 channels, GPI, AES and analog audio I/O. HDMI monitor output & dual PSUs.

### 6114130

SV4000-CD4 Quad channel video & audio processing unit, including format conversion, frame synchronization, ARC control, noise reduction, side-bar keying, logo insertion, CC, WST and timecode handling, picture enhancement tools, 16-channel audio processing inc gain, delay & shuffling. SDI (BNC or fiber), GPI, AES and analog audio I/O, CVBS decode available for four channels. HDMI monitor output & dual PSUs.

### 6114150

SV4000-CE4 Quad channel video & audio processing unit, including format conversion, frame synchronization, ARC control, noise reduction, side-bar keying, logo insertion, CC, WST and timecode handling, picture enhancement tools, 16-channel audio processing inc gain, delay & shuffling. SDI (BNC or fiber), GPI, AES and analog audio I/O, CVBS encode available for four channels. HDMI monitor output & dual PSUs.

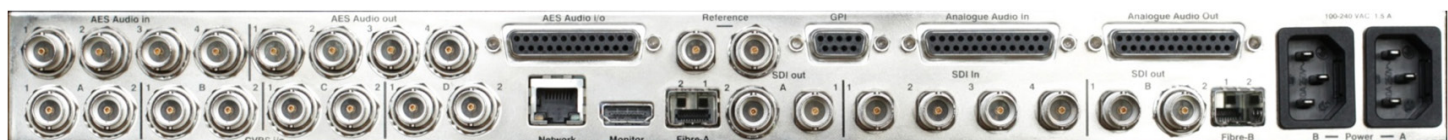

# MC1000-IQ and MC2000-IQ

## Motion Compensated Standards Converters

MC1000-IQ and MC2000-IQ are cost-effective motion compensated standards converters with space for up to two additional IQ modules.



### KEY FEATURES

- Motion compensated SD/HD/3G frame rate conversion
- SD/HD/3G up-, down- and crossconversion
- Independent dual channel conversion (MC2000-IQ only)
- Flexible video and audio I/O configuration
- 16-channel embedded audio processing for each video channel
- Continuous output when input standard switches
- HDMI monitor output
- Dual PSU as standard
- Relay bypass on primary SDI inputs
- Automatic aspect ratio conversion (AFD, VI, L23)
- Powerful picture enhancement tools
- Front panel and remote control via web interface and RollCall
- Closed caption and timecode handling
- Synchronization

- User chosen line for SMPTE ST 2016
- GPI support
- Front panel control lock
- SMPTE ST 2020 metadata support
- Caption generator
- Logo inserter
- Sidebar keyer
- Clean cut

#### Optional Features

- Fiber input/output

#### Applications

- International program distribution
- Content repurposing for internet, TV and Blu-ray distribution
- International TV and video production

### MC1000-IQ Video Processing

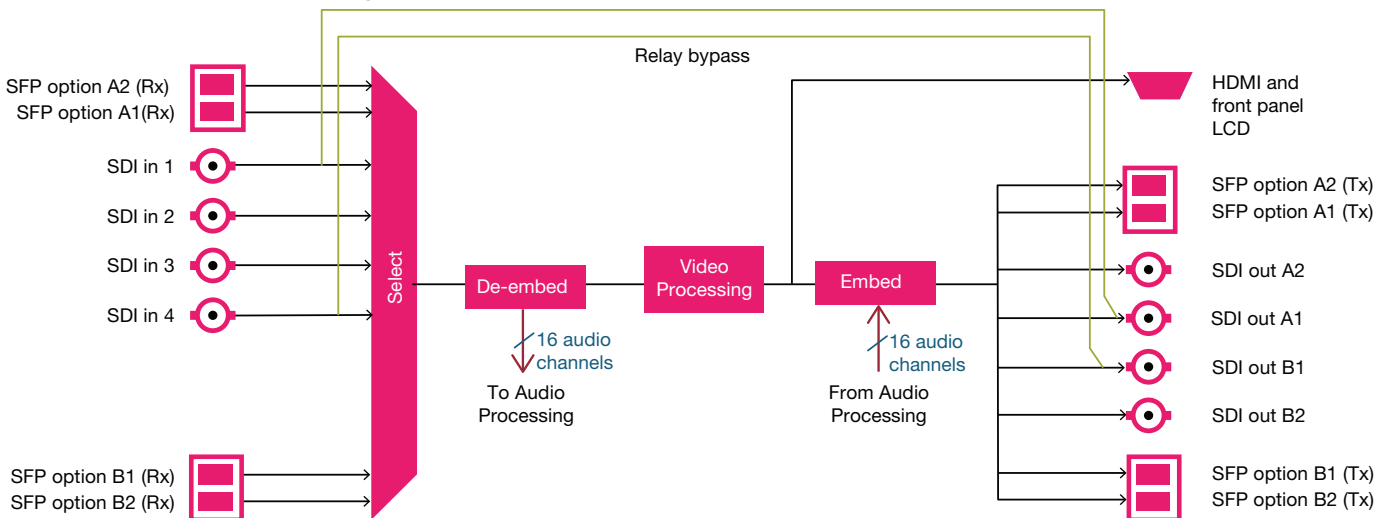

### MC1000-IQ Audio Processing

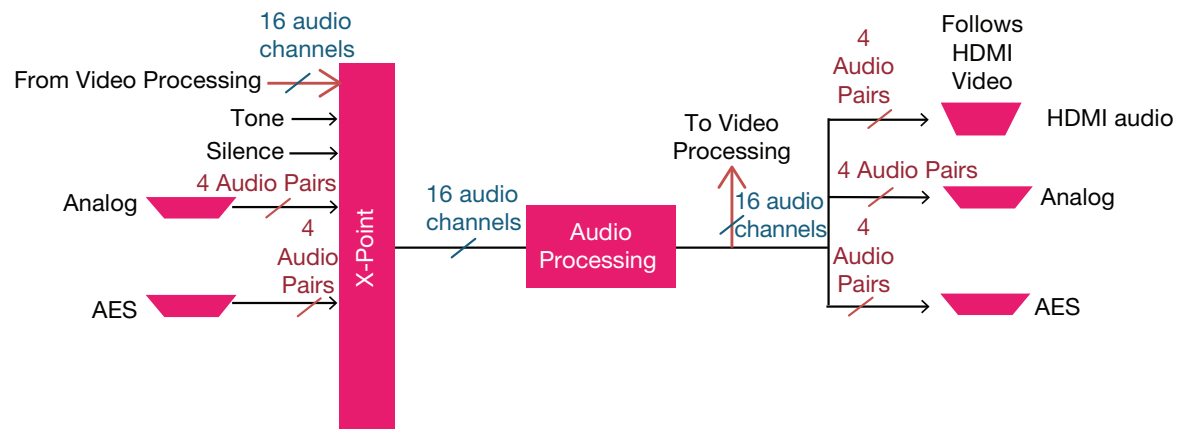

MC2000-IQ Video Processing

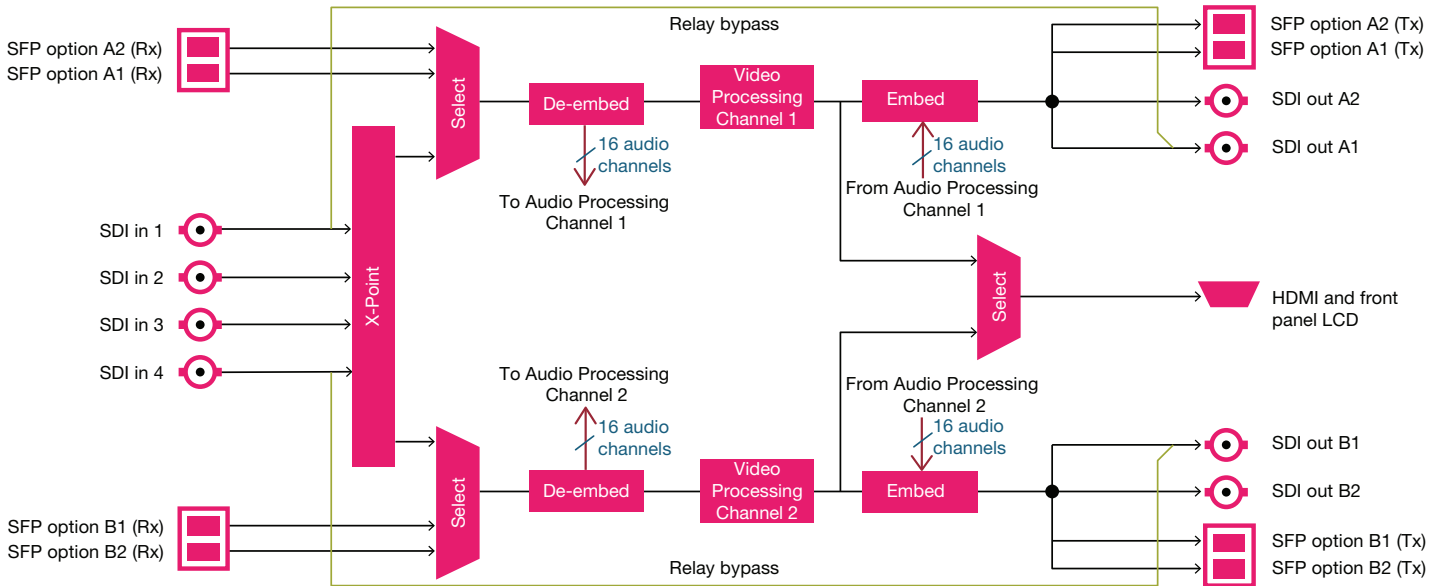

MC2000-IQ Audio Processing

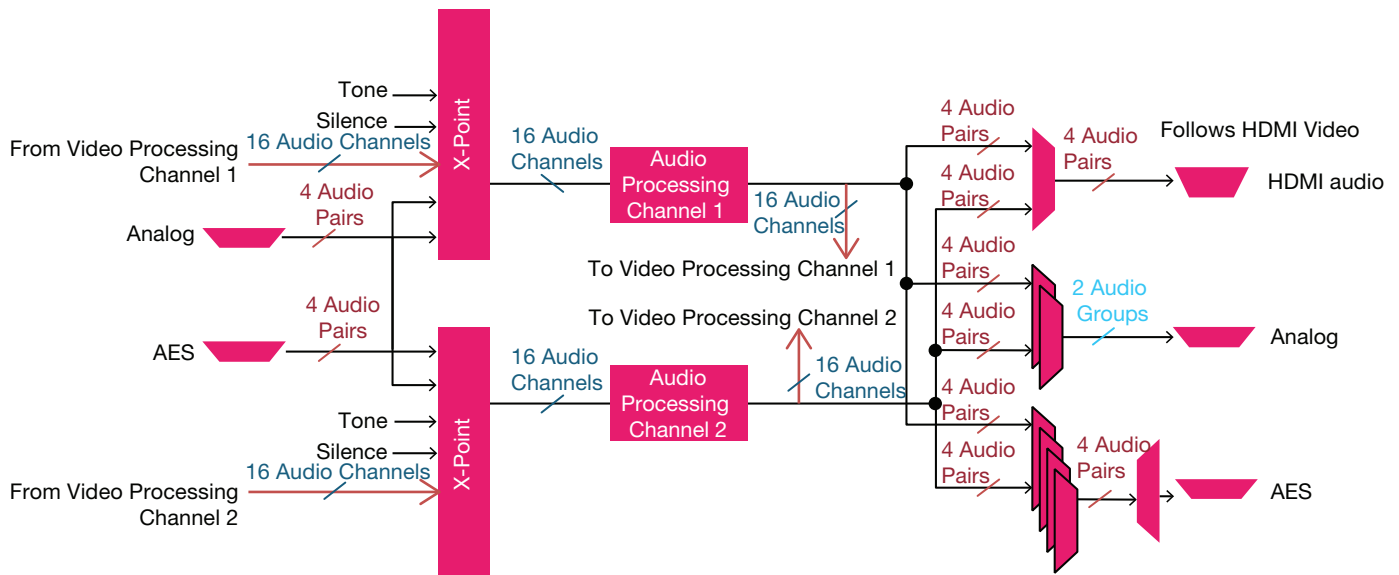



# KudosPro & KudosPro-IQ Single, Dual and Quad Channel Format and Frame Rate Conversion

## SPECIFICATIONS

### Signal Inputs

Serial digital 4x 75Ω SD/HD/3G serial digital with embedded audio

#### Input standards:

- 3 Gb/s SD-SDI, SMPTE ST 425 level A, level B
- 1.5 Gb/s HD-SDI SMPTE ST 292/SMPTE ST 299
- 270 Mb/s SD-SDI SMPTE ST 259

**Reference:** 1x loop-through HDTV Trisync/SD Bi-sync (black & burst) SMPTE ST 240/SMPTE ST 274

**Audio AES:** 4x balanced AES inputs – via 25-way D-Type

**Audio analog:** 4 x stereo analog inputs via 25-way D-Type

### Signal Outputs

Serial digital 4x 75Ω SD/HD/3G serial digital with embedded audio

#### Output standards:

- 3 Gb/s HD-SDI, SMPTE ST 425 level A, level B
- 1.5 Gb/s HD-SDI SMPTE ST 292/SMPTE ST 299
- 270 Mb/s SD-SDI SMPTE ST 259

**Audio AES:** 4x balanced AES outputs – via 25-way D-Type

**Audio analog:** 2x stereo analog outputs via 25-way D-Type

### Input Standards

(auto detect) 525, 625

720 50/59.94/60p

1080 50/59.94/60i

1080 50/59.94/60p (Levels A and B)

720/1080 23/24/25/29/30p

1080 23/24/25/29psf

### Output Standards

525, 625

720 50/59.94/60p

1080 50/59.94/60i

1080 50/59.94/60p (Levels A and B)

720/1080 23/24/25/29/30p

1080 23/24/25/29psf

### Conversion Functions

**Modes:** SD/HD/3G Motion Compensated

**Standards Conversion:** Upconversion, Down-conversion, Crossconversion

Conversion Linear/motion compensated Conversion processing

**Still process:** Detects still images and applies an aperture with full (progressive) vertical frequency response.

**Enhanced still:** Adds field motion detection to still process. Prevents artifacts on moving repetitive patterns.

### Manual or Automatic ARC

AFD (SMPTE ST 2016), VI (RP186), WSS (L23)

**SD input format:** Normal 4:3, Anamorphic 16:9, Letterbox 14:9, Letterbox 16:9

**SD output format:** Normal 4:3, Anamorphic 16:9, Letterbox 14:9, Letterbox 16:9

**Auto zoom:** On/Off

**Manual zoom:** Zoom  $\pm 20\%$

**Safe area marker:** Off, 16:9, 4:3

**Manual controls:** size, aspect, pan, tilt

Wide range of ARC presets including 702 sample line mode

### Audio Functions

#### Analog Audio:

Four pairs of analog inputs are individually available to any or all processing channels

Two groups (2 pairs) of analog output are separately assignable to any processing channel

Headroom +24 dBu; balanced connection

#### AES Audio:

Four AES audio inputs are individually available to any or all processing channels

Four AES audio outputs (48 kHz) are separately assignable to any processing channel  
AES input is auto-detected as PCM (32-96 kHz) or non-PCM (48 kHz locked to relevant video input)

#### Embedded Audio:

Each processing channel includes 16-channel embedded audio processing

PCM audio processing includes channel level gain and delay compensation, as well as channel level routing/shuffle with audio phase inversion

Non-PCM processing features pair level routing and delay compensation

Dolby-E data is passed with a delay to match the video and with co-timed audio frame drop or repeat

### Metadata

Closed caption CEA608 <> CEA708

Timecode conversions

WST/RDD8 conversion

SMPTE ST 2020 embed/de-embed

### Enhancement

#### Advanced Horizontal Enhancement:

Frequency band selection (Low, Med, High)

4 preset enhancement levels (Soft 2, Soft 1, Normal, Sharp 1, Sharp 2)

Custom H Gain and H Noise rejection levels

#### Advanced Vertical Enhancement:

Frequency band selection (Low, Med, High)

5 preset enhancement levels (Soft, Normal, Sharp 1, Sharp 2, Sharp 3)

#### Horizontal Aperture:

5 preset H sharpness levels (Low 2, Low 1, Normal, High 1, High 2)

5 preset H detail levels (Soft 2, Soft 1, Normal, Sharp 1, Sharp 2)

#### Noise reduction:

spatial, recursive

### System

Pattern Off, Black, Ramp, Bars

Proc amp

**Black Level:** +100 to -100 mV (0) in 0.8 mV steps

**Contrast:** -6 dB to +6 dB (0) in 0.2 dB steps

**Saturation:** -6 dB to +6 dB (0) in 0.2 dB steps

**Y Gamma:** 0.4 to 1.7 (1) in 0.1 steps

**Freeze:** On/Off

**Genlock:** Reference lock, Input lock (same format), Follow input (same frame rate), Free run

**Memories:** 16 user memories

Legalizer

EDH support

### Communications

Remote control via web interface and RollCall network (IP)

### Power (Primary and Secondary)

**Input voltage range:** 100 – 240 VAC, 50/60 Hz 1.5A (max.) via three-pin IEC power socket

### Mechanical

**Temperature range:** 0 to 45° C (32° to 113° F) operating

**Cooling:** Internal fan, side venting

**Weight:** Approximately 4.25 kg (9.4 lbs.)

**Case type:** 1 RU, rack mounting

**Dimensions:** 44 mm x 430 mm x 400 mm (1.7 x 16.9 x 15.7 in.) (HxWxD)

Headphones socket with volume control

**GPIO:** 8 available

### Throughput Delay

#### Video processing delay:

**Field = 16.7 or 20 ms**

**Frame = 33.3 or 40 ms**

With scaling active in same frame rate:

Ref lock/Free run – Between 3 and 5 fields + ~200  $\mu$ s

Input lock (SDI) – 3 fields + 1 ms

With same standard in & out and sync mode = Enabled:

Ref lock/Free run – Between ~200  $\mu$ s and 1 frame + ~200  $\mu$ s

Input lock (SDI) – ~1 ms

Frame rate conversion: Any lock mode – 110 ms typical

#### Audio processing delay: (Audio delay = 0 ms)

With scaling active in same frame rate:

Ref lock/Free run – 1.5 frames

Input lock – 1 frame + 1 ms

With same standard in & out and sync mode = Enabled:

Ref lock Free run – 0.5 frames

Input lock – ~3 ms

Frame rate conversion: Any lock mode – 110 ms typical

## ORDERING

### 6131200

MC1000-IQ Single channel motion compensated frame rate converter with space for up to two IQ modules. Including frame synchronization, ARC control, noise reduction, side-bar keying, logo insertion, CC, WST and timecode handling, picture enhancement tools, 16-channel audio processing inc gain, delay & shuffling. SDI (BNC or fiber), GPI, balanced AES and analog audio I/O. HDMI monitor output & dual PSUs.

### 6132200

MC2000-IQ Dual channel motion compensated frame rate converter with space for up to two IQ modules. Featuring frame rate/format conversion, frame synchronization, ARC control, noise reduction, side-bar keying, logo insertion, CC, WST and timecode handling, picture enhancement tools, 16-channel audio processing inc gain, delay & shuffling. SDI (BNC or fiber), GPI, balanced AES and analog audio I/O. HDMI monitor output & dual PSUs.

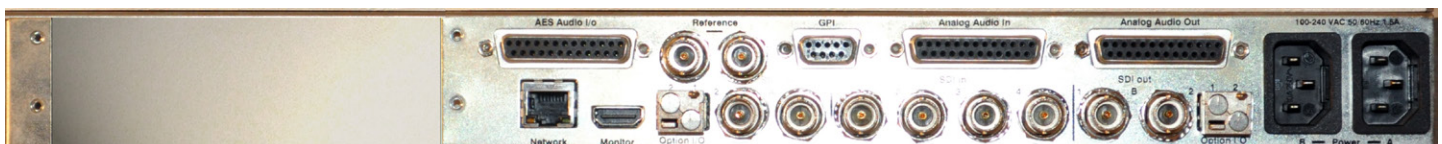

Rear panel shows MC1000-IQ with no IQ modules fitted.

# LC2000-IQ and LC4000-IQ

## Motion Adaptive Standards Converters

LC2000-IQ and LC4000-IQ are highly cost-effective, linear motion adaptive standards converters with space for up to two additional IQ modules.



### KEY FEATURES

- Linear motion adaptive SD/HD/3G high-density frame rate conversion
- SD/HD/3G up-, down- and crossconversion
- Independent dual channel (LC2000-IQ) and quad channel conversion (LC4000-IQ)
- Flexible video and audio I/O configuration
- 16-channel embedded audio processing for each video channel
- Continuous output when input standard switches
- HDMI monitor output
- Dual PSU as standard
- Relay bypass on primary SDI inputs
- Automatic aspect ratio conversion (AFD, VI, L23)
- Powerful picture enhancement tools
- Front panel and remote control via web interface and RollCall
- Closed caption and timecode handling
- Synchronization
- User chosen line for SMPTE ST 2016
- GPI support
- Front panel control lock
- SMPTE ST 2020 metadata support
- Caption generator
- Logo inserter
- Sidebar keyer
- Clean cut

#### Optional Features

- Fiber input/output

#### Applications

- High density international program distribution
- Low-cost frame rate conversion
- International TV and video back-up channels

### LC2000-IQ Video Processing

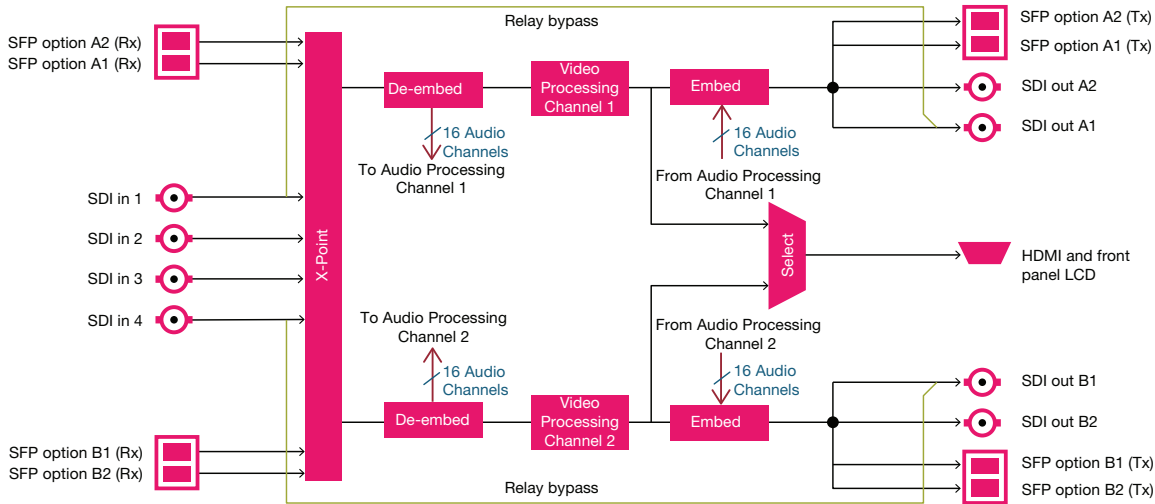

### LC2000-IQ Audio Processing

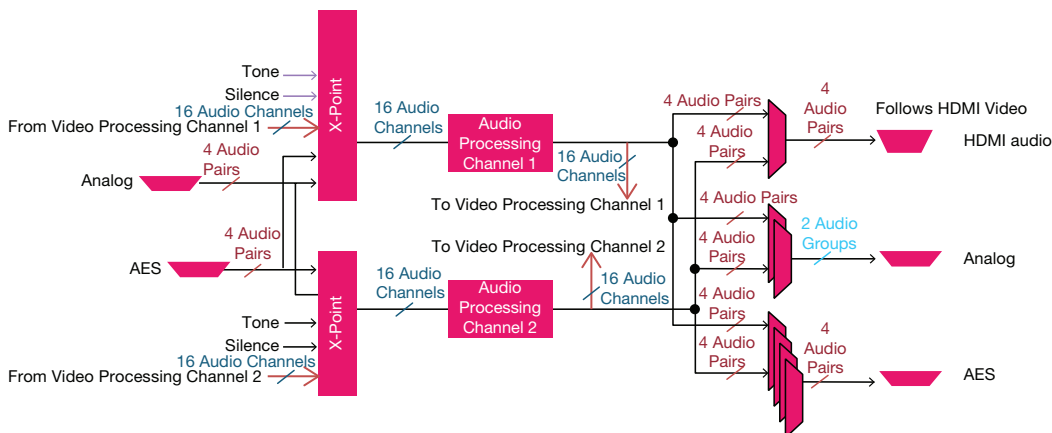

LC4000-IQ Video Processing

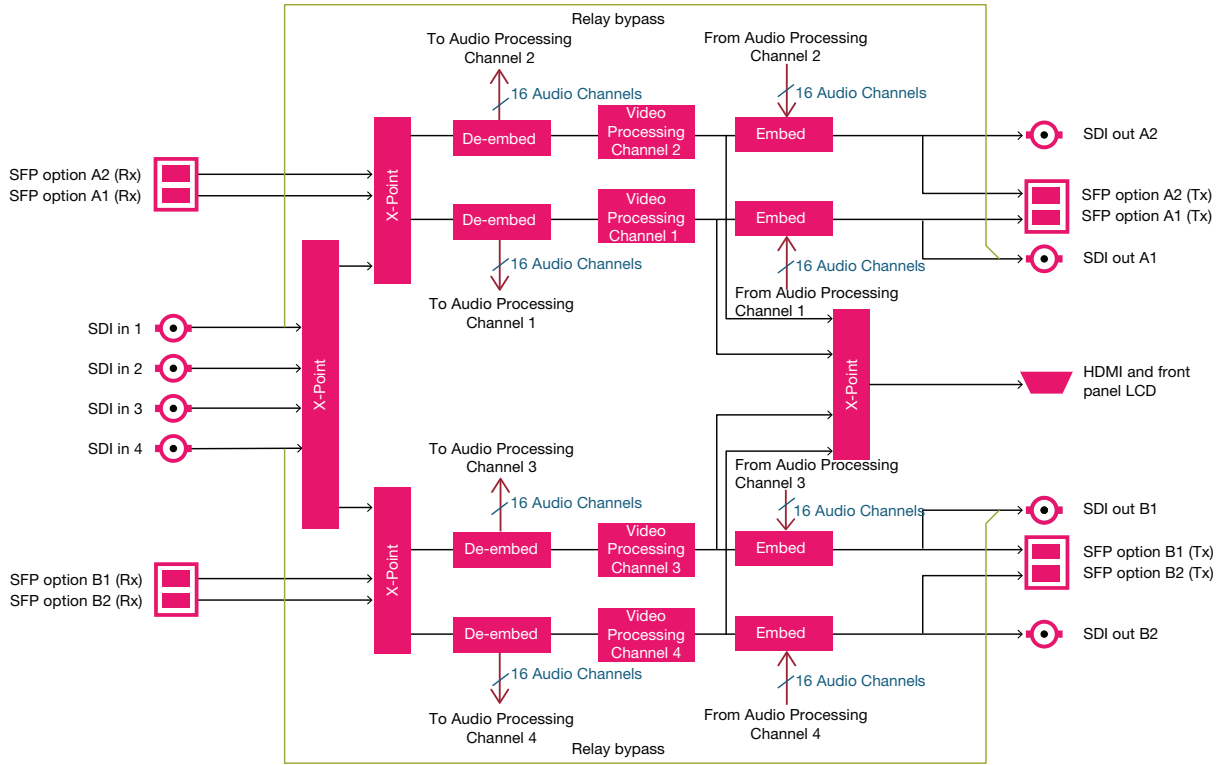

LC4000-IQ Audio Processing

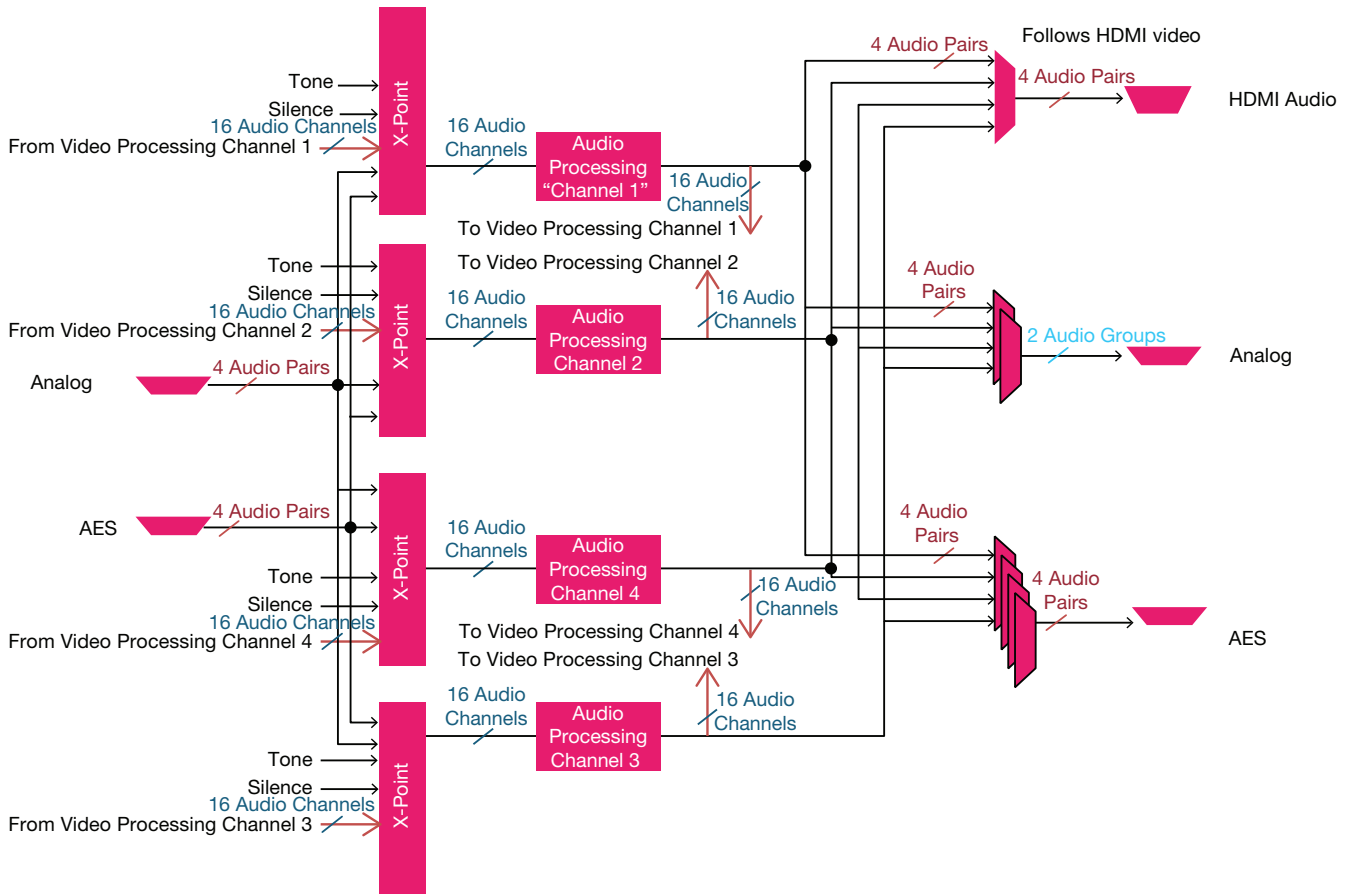

# KudosPro & KudosPro-IQ Single, Dual and Quad Channel Format and Frame Rate Conversion

## SPECIFICATIONS

### Signal Inputs

Serial digital 4x 75Ω SD/HD/3G serial digital with embedded audio

#### Input standards:

- 3 Gb/s SD-SDI, SMPTE ST 425 level A, level B
- 1.5 Gb/s HD-SDI SMPTE ST 292/SMPTE ST 299
- 270 Mb/s SD-SDI SMPTE ST 259

**Reference:** 1x loop-through HDTV Trisync/SD Bi-sync (black & burst) SMPTE ST 240/SMPTE ST 274

**Audio AES:** 4x balanced AES inputs – via 25-way D-Type

**Audio analog:** 4x stereo analog inputs via 25-way D-Type

### Signal Outputs

Serial digital 4x 75Ω SD/HD/3G serial digital with embedded audio

#### Output standards:

- 3 Gb/s HD-SDI, SMPTE ST 425 level A, level B
- 1.5 Gb/s HD-SDI SMPTE ST 292/SMPTE ST 299
- 270 Mb/s SD-SDI SMPTE ST 259

**Audio AES:** 4x balanced AES outputs – via 25-way D-Type

**Audio analog:** 2x stereo analog outputs via 25-way D-Type

### Input Standards

(auto detect) 525, 625

720 50/59.94/60p

1080 50/59.94/60i

1080 50/59.94/60p (Levels A and B)

720/1080 23/24/25/29/30p

1080 23/24/25/29psf

### Output Standards

525, 625

720 50/59.94/60p

1080 50/59.94/60i

1080 50/59.94/60p (Levels A and B)

720/1080 23/24/25/29/30p

1080 23/24/25/29psf

### Conversion Functions

**Modes:** SD/HD/3G Motion Compensated

**Standards Conversion:** Upconversion, Down-conversion, Crossconversion

Conversion linear/motion compensated  
Conversion processing

**Still process:** Detects still images and applies an aperture with full (progressive) vertical frequency response

**Enhanced still:** Adds field motion detection to still process. Prevents artifacts on moving repetitive patterns.

### Manual or Automatic ARC

AFD (SMPTE ST 2016), VI (RP186), WSS (L23)

**SD input format:** Normal 4:3, Anamorphic 16:9, Letterbox 14:9, Letterbox 16:9

**SD output format:** Normal 4:3, Anamorphic 16:9, Letterbox 14:9, Letterbox 16:9

**Auto zoom:** On/Off

**Manual zoom:** Zoom  $\pm 20\%$

**Safe area marker:** Off, 16:9, 4:3

**Manual controls:** size, aspect, pan, tilt

Wide range of ARC presets including 702 sample line mode

### Audio Functions

#### Audio Audio:

Four pairs of analog inputs are individually available to any or all processing channels

Two groups (2 pairs) of analogue output are separately assignable to any processing channel

Headroom +24 dBu; balanced connection

#### AES Audio:

Four AES audio inputs are individually available to any or all processing channels

Four AES audio outputs (48 kHz) are separately assignable to any processing channel  
AES input is auto-detected as PCM (32-96 kHz) or non-PCM (48 kHz locked to relevant video input)

#### Embedded Audio:

Each processing channel includes 16-channel embedded audio processing

PCM audio processing includes channel level gain and delay compensation, as well as channel level routing/shuffle with audio phase inversion

Non-PCM processing features pair level routing and delay compensation

Dolby-E data is passed with a delay to match the video and with co-timed audio frame drop or repeat

### Metadata

Closed caption CEA608 <> CEA708

Timecode conversions

WST/RDD8 conversion

SMPTE ST 2020 embed/de-embed

### Enhancement

#### Advanced Horizontal Enhancement:

Frequency band selection (Low, Med, High)

4 preset enhancement levels (Soft 2, Soft 1, Normal, Sharp 1, Sharp 2)

Custom H Gain and H Noise rejection levels

#### Advanced Vertical Enhancement:

Frequency band selection (Low, Med, High)

5 preset enhancement levels (Soft, Normal, Sharp 1, Sharp 2, Sharp 3)

#### Horizontal Aperture:

5 preset H sharpness levels (Low 2, Low 1, Normal, High 1, High 2)

5 preset H detail levels (Soft 2, Soft 1, Normal, Sharp 1, Sharp 2)

#### Noise reduction: spatial, recursive

### System

Pattern Off, Black, Ramp, Bars

Proc amp

**Black Level:** +100 to -100 mV (0) in 0.8 mV steps

**Contrast:** -6 dB to +6 dB (0) in 0.2 dB steps

**Saturation:** -6 dB to +6 dB (0) in 0.2 dB steps

**Y Gamma:** 0.4 to 1.7 (1) in 0.1 steps

**Freeze:** On/Off

**Genlock:** Reference lock, Input lock (same format), Follow input (same frame rate), Free run

**Memories:** 16 user memories

Legalizer

EDH support

### Communications

Remote control via web interface and RollCall network (IP)

### Power (Primary and Secondary)

**Input voltage range:** 100 – 240 VAC, 50/60 Hz 1.5A (max.) via three-pin IEC power socket

### Mechanical

**Temperature range:** 0 to 45° C (32° to 113° F) operating

**Cooling:** Internal fan, side venting

**Weight:** Approximately 4.25 kg (9.4 lbs.)

**Case type:** 1 RU, rack mounting

**Dimensions:** 44 x 430 x 400 mm (1.7 x 16.9 x 15.7 in.) (HxWxD)

Headphones socket with volume control

**GPIO:** 8 available

### Throughput Delay

#### Video processing delay:

**Field = 16.7 or 20 ms**

**Frame = 33.3 or 40 ms**

With scaling active in same frame rate:

Ref lock/Free run – between 3 and 5 fields + ~200  $\mu$ s

Input lock(SDI) – 3 fields + 1 ms

With same standard in & out and sync mode = Enabled:

Ref lock/Free run – Between ~200  $\mu$ s and 1 frame + ~200  $\mu$ s

Input lock(SDI) – ~1 ms

**Frame rate conversion:** Any lock mode – 110 ms typical

#### Audio processing delay (Audio delay = 0 ms)

With scaling active in same frame rate:

Ref lock/Free run – 1.5 frames

Input lock – 1 frame + 1 ms

With same standard in & out and sync mode = Enabled:

Ref lock/Free run – 0.5 frames

Input lock – ~3 ms

**Frame rate conversion:** Any lock mode – 110 ms typical

## ORDERING

### 6122200

LC2000-IQ Dual channel video & audio processing unit with space for up to two IQ modules. Featuring frame rate/format conversion, frame synchronization, ARC control, noise reduction, side-bar keying, logo insertion, CC, WST and timecode handling, picture enhancement tools, 16-channel audio processing inc gain, delay & shuffling. SDI (BNC or fiber), GPI, balanced AES and analog audio I/O. HDMI monitor output & Dual PSUs.

### 6124200

LC4000-IQ Quad channel video & audio processing unit with space for up to two IQ modules. Featuring frame rate/format conversion, frame synchronization, ARC control, noise reduction, side-bar keying, logo insertion, CC, WST and timecode handling, picture enhancement tools, 16-channel audio processing inc gain, delay & shuffling. SDI (BNC or fiber), GPI, balanced AES and analog audio I/O. HDMI monitor output & dual PSUs.

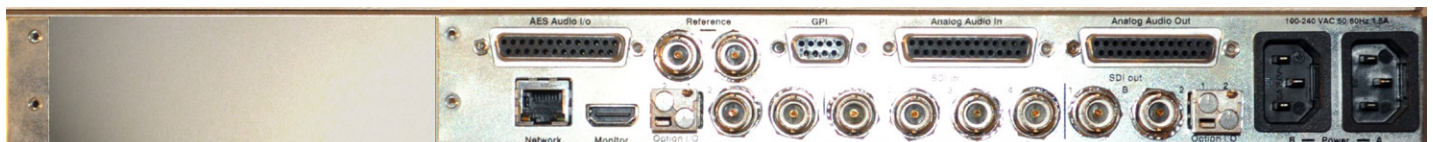

Rear panel shows LC2000-IQ with no IQ modules fitted.

# SV2000-IQ and SV4000-IQ

## Up/Down/Crossconverters

SV2000-IQ and SV4000-IQ are low-cost, high-density up-, down-, and crossconverters with space for up to two additional IQ modules.



### KEY FEATURES

- SD/HD/3G up-, down- and crossconversion
- Independent dual channel (SV2000-IQ) and quad channel conversion (SV4000-IQ)
- Frame synchronization
- Flexible video and audio I/O configuration
- 16-channel embedded audio processing for each video channel
- Continuous output when input standard switches
- HDMI monitor output
- Dual PSU as standard
- Relay bypass on primary SDI inputs
- Automatic aspect ratio conversion (AFD, VI, L23)
- Powerful picture enhancement tools
- User friendly front panel as well as remote control via web interface and RollCall
- Closed caption and timecode handling
- User chosen line for SMPTE ST 2016
- GPI support
- Front panel control lock
- SMPTE2020 metadata support
- Caption generator
- Logo inserter
- Sidebar keyer
- Clean cut

#### Optional Features

- Fiber input/output

#### Applications

- Integration of SD programming into HD schedules
- Supporting legacy SD channels with HD produced content
- Future-proofing investments up to 1080p 3 Gb/s

### SV2000-IQ Video Processing

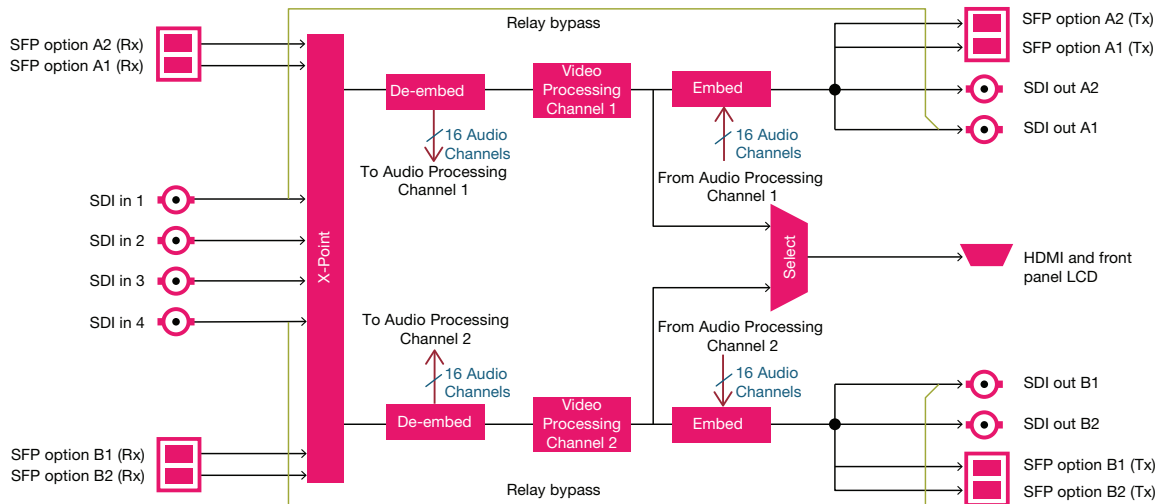

### SV2000-IQ Audio Processing

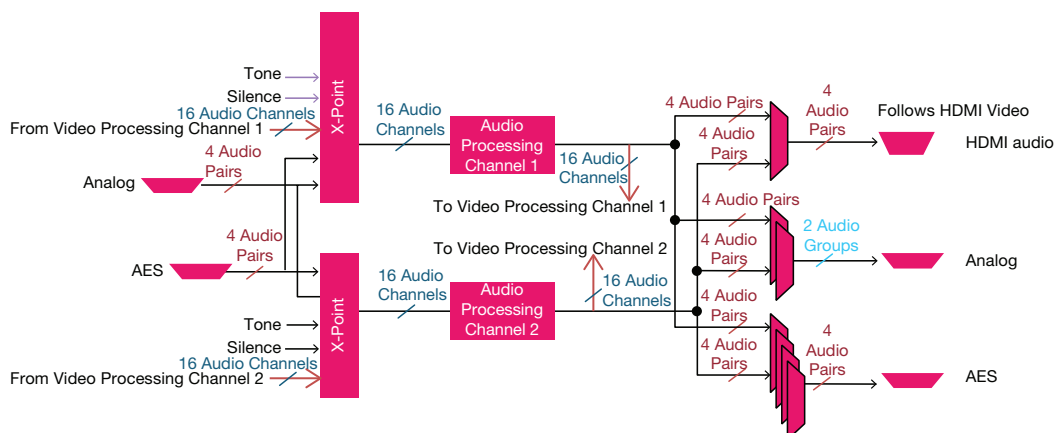



SV4000-IQ Video Processing

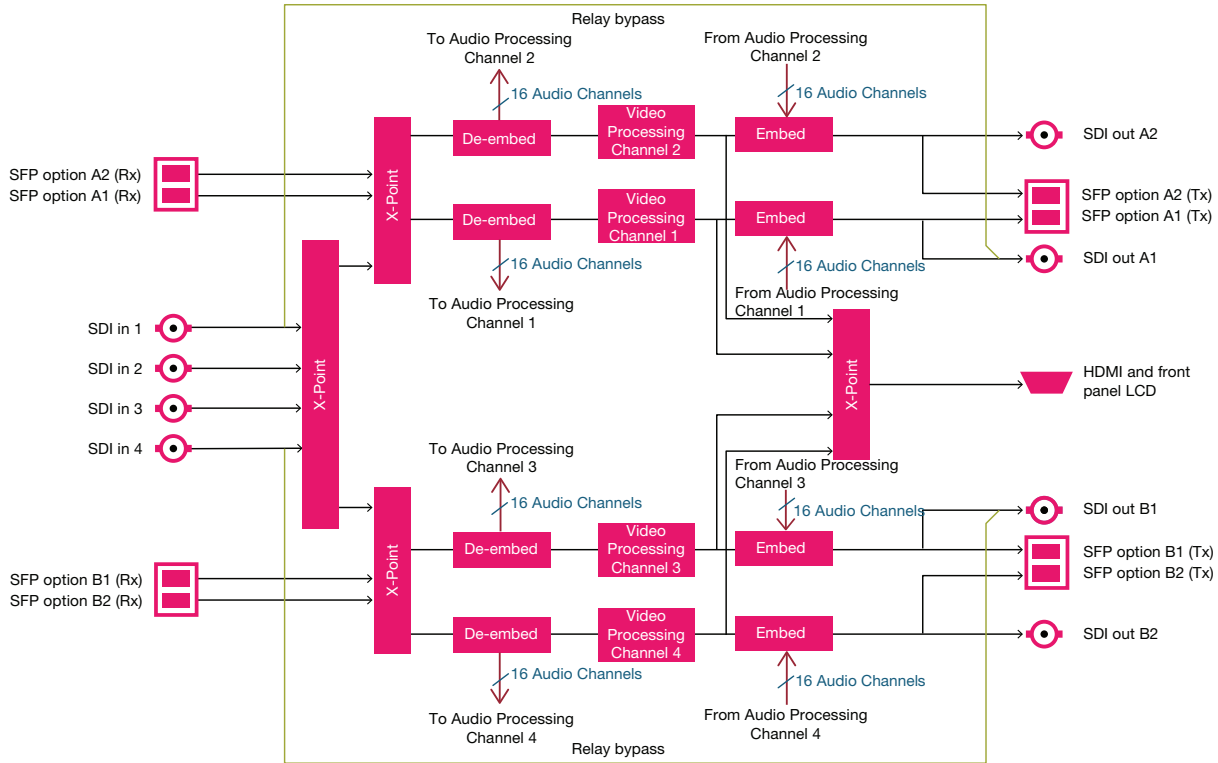

SV4000-IQ Audio Processing

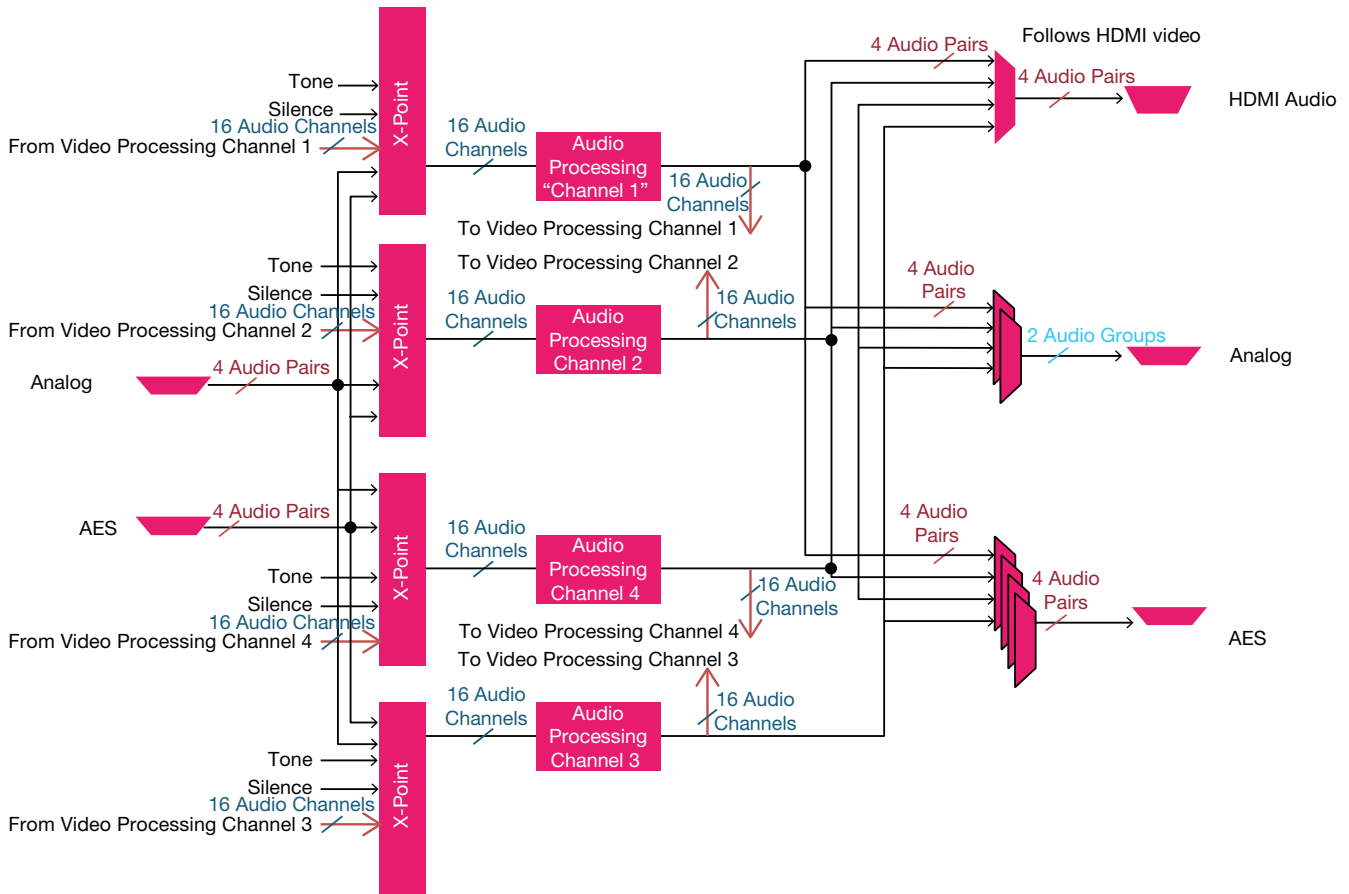

## SPECIFICATIONS

### Signal Inputs

Serial digital 4x 75Ω SD/HD/3G serial digital with embedded audio

#### Input standards:

- 3 Gb/s SD-SDI, SMPTEST 425 level A, level B
- 1.5 Gb/s HD-SDI SMPTE ST 292/SMPTE ST 299M
- 270 Mb/s SD-SDI SMPTE ST 259

**Reference:** 1 x loop-through HDTV Trisync/SD Bi-sync (black & burst) SMPTE ST 240/SMPTE ST 274

**Audio AES:** 4x balanced AES inputs – via 25-way D-Type

**Audio analog:** 4x stereo analog inputs via 25-way D-Type

### Signal Outputs

Serial digital 4x 75Ω SD/HD/3G serial digital with embedded audio

#### Output standards:

- 3 Gb/s HD-SDI, SMPTE ST 425 level A, level B
- 1.5 Gb/s HD-SDI SMPTE ST 292/SMPTE ST 299
- 270 Mb/s SD-SDI SMPTE ST 259

**Audio AES:** 4x balanced AES outputs – via 25-way D-Type

**Audio analog:** 2x stereo analog outputs via 25-way D-Type

### Input Standards

(auto detect) 525, 625

720 50/59.94/60p

1080 50/59.94/60i

1080 50/59.94/60p (Levels A and B)

720/1080 23/24/25/29/30p

1080 23/24/25/29psf

### Output Standards

525, 625

720 50/59.94/60p

1080 50/59.94/60i

1080 50/59.94/60p (Levels A and B)

720/1080 23/24/25/29/30p

1080 23/24/25/29psf

### Conversion Functions

**Modes:** SD/HD/3 Gb/s Upconversion, Downconversion, Crossconversion at the same frame rate

#### Manual or Automatic ARC

AFD (SMPTE ST 2016), VI (RP186), WSS (L23)

**SD input format:** Normal 4:3, Anamorphic 16:9, Letterbox 14:9, Letterbox 16:9

**SD output format:** Normal 4:3, Anamorphic 16:9, Letterbox 14:9, Letterbox 16:9

**Auto zoom:** On/Off

**Manual zoom:** Zoom ±20%

**Safe area marker:** Off, 16:9, 4:3

**Manual controls:** size, aspect, pan, tilt

Wide range of ARC presets including 702 sample line mode

### Audio Functions

#### Analog Audio:

Four pairs of analog inputs are individually available to any or all processing channels

Two groups (2 pairs) of analog output are separately assignable to any processing channel

Headroom +24 dBu; balanced connection

#### AES Audio:

Four AES audio inputs are individually available to any or all processing channels

Four AES audio outputs (48 kHz) are separately assignable to any processing channel  
AES input is auto-detected as PCM (32-96 kHz) or non-PCM (48 kHz locked to relevant video input)

#### Embedded Audio:

Each processing channel includes 16-channel embedded audio processing

PCM audio processing includes channel level gain and delay compensation, as well as channel level routing/shuffle with audio phase inversion

Non-PCM processing features pair level routing and delay compensation

Dolby-E data is passed with a delay to match the video and with co-timed audio frame drop or repeat

### Metadata

Closed caption CEA608 <> CEA708

Timecode conversions

WST/RDD8 conversion

SMPTE ST 2020 embed/de-embed

### Enhancement

#### Advanced Horizontal Enhancement:

Frequency band selection (Low, Med, High)

4 preset enhancement levels (Low, Med, High, Super)

Custom H Gain and H Noise rejection levels

#### Advanced Vertical Enhancement:

Frequency band selection (Low, Med, High)

5 preset enhancement levels (Soft 2, Soft 1, Normal, Sharp 1, Sharp 2)

#### Horizontal Aperture:

5 preset H sharpness levels (Low 2, Low 1, Normal, High 1, High 2)

5 preset H detail levels (Soft 2, Soft 1, Normal, Sharp 1, Sharp 2)

#### Noise reduction: spatial, recursive

### System

Pattern Off, Black, Ramp, Bars

Proc amp

**Black Level:** +100 to -100 mV (0) in 0.8 mV steps

**Contrast:** -6 dB to +6 dB (0) in 0.2 dB steps

**Saturation:** -6 dB to +6 dB (0) in 0.2 dB steps

**Y Gamma:** 0.4 to 1.7 (1) in 0.1 steps

**Freeze:** On/Off

**Genlock:** Reference lock, Input lock (same format), Follow input (same frame rate), Free run

**Memories:** 16 user memories

Legalizer

EDH support

### Communications

Remote control via web interface and RollCall network (IP)

### Power (Primary and Secondary)

**Input voltage range:** 100 – 240 VAC, 50/60 Hz  
1.5A (max.) via three-pin IEC power socket

### Mechanical

**Temperature range:** 0 to 45° C (32° to 113° F) operating

**Cooling:** Internal fan, side venting

**Weight:** Approximately 4.25 kg (9.4 lbs.)

**Case type:** 1 RU, rack mounting

**Dimensions:** 44 x 430 x 400 mm (1.7 x 16.9 x 15.7 in.) (HxWxD)

Headphones socket with volume control

**GPIO:** 8 available

### Throughput Delay

#### Video processing delay:

**Field = 16.7 or 20 ms**

**Frame = 33.3 or 40 ms**

With scaling active in same frame rate:

Ref lock/Free run – Between 3 and 5 fields + ~200 μs

Input lock (SDI) – 3 fields + 1ms

With same standard in & out and sync mode = Enabled:

Ref lock/Free run – Between ~200 μs and 1 frame + ~200 μs

Input lock (SDI) – ~1 ms

Frame rate conversion: Any lock mode – 110 ms typical

#### Audio processing delay: (Audio delay = 0 ms)

With scaling active in same frame rate:

Ref lock/Free run – 1.5 frames

Input lock – 1 frame + 1 ms

With same standard in & out and sync mode = Enabled:

Ref lock Free run – 0.5 frames

Input lock – ~3 ms

Frame rate conversion: Any lock mode – 110 ms typical

## ORDERING

### 6112200

SV2000-IQ Dual channel video & audio processing unit with space for up to two IQ modules. Featuring format conversion, frame synchronization, ARC control, noise reduction, side-bar keying, logo insertion, CC, WST and timecode handling, picture enhancement tools, 16-channel audio processing inc gain, delay & shuffling. SDI (BNC or fiber), GPI, balanced AES and analog audio I/O. HDMI monitor output & dual PSUs.

### 6114200

SV4000-IQ Quad channel video & audio processing unit with space for up to two IQ modules. Featuring format conversion, frame synchronization, ARC control, noise reduction, side-bar keying, logo insertion, CC, WST and timecode handling, picture enhancement tools, 16-channel audio processing inc gain, delay & shuffling. SDI (BNC or fiber), GPI, balanced AES and analog audio I/O. HDMI monitor output & dual PSUs.

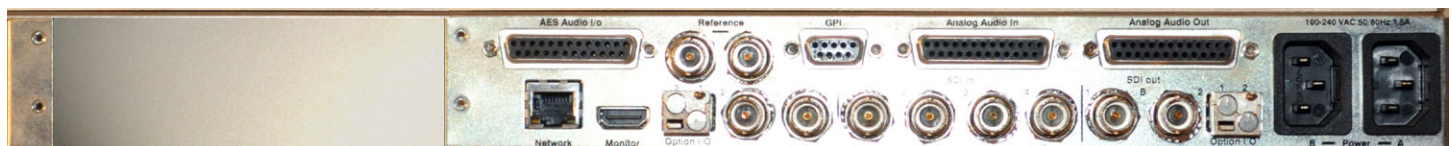

Rear panel shows SV2000-IQ with no IQ modules fitted.

## Customize your KudosPro-IQ unit by adding Grass Valley IQ Modules

KudosPro-IQ includes two single-width IQ Modular slots that are accessed via the rear panel. This allows two single-width IQ modules or one double-width module to be installed. Installation is simple, and is via the rear panel.



Addition of single-width module.



Addition of dual-width module.

Connectivity between the KudosPro interface and the IQ module is achieved via external connection. The installed IQ modules can be controlled and monitored by RollCall in the same way as KudosPro. (Note that control of the modules from the KudosPro front panel is not available).

### Applications Overview

Addition of Grass Valley IQ modules to KudosPro-IQ units adds a wealth of functionality for a range of applications. Here are just some of the applications supported:

#### Signal Monitoring

In a transmission chain, it's critical to ensure that the correct signal is being sent to the desired destination, and that the signal quality (e.g., audio and video levels) is as required. Where KudosPro-IQ units are used for conversion in the signal path, adding Grass Valley's intelligent signal monitoring solution, Hyperion, can provide critical signal confidence. For example, IQHIP10 could be added to an MC2000-IQ to monitor the main incoming signal, allowing an operator to change over to a backup source, if the IQHIP10 reports main signal loss or errors. The changeover can be automated, e.g., by using IQHCO51 in the second module slot.

For visual monitoring of four incoming or four outgoing signals, the IQQSM00 quad-split monitor is a useful addition to LC4000-IQ or SV4000-IQ. Using the IQQSM00, an operator can visually verify up to four incoming or outgoing sources on one HD monitor.

The detailed application example "Quad Split Monitor" (shown at right) gives more information on this application.

#### Signal Protection

The IQHCO51 provides back-up protection for SDI signal paths with a clean switching feature. Based on input monitoring detection of signal errors, an automatic change-over to a back-up feed can be initiated on detection of an error state. A powerful rules engine is available to provide logical conditions for auto-switching, whilst GPI (or RollTrack) inputs can force the unit to switch independent of signal state.

Since IQHCO51 is a single-width module, two IQHCO51 modules may be fitted into a KudosPro-IQ channel product allowing signal protection for any two of the four input feeds.

#### Loudness Monitoring

In transmission chains where loudness control is essential to meet legal requirements, a customer may fit, for example, the IQSYN33 module which has optional Linear Acoustic loudness processing. This is a double-width module so only one channel of loudness processing is available.

Combined with Grass Valley's award winning RollCall product suite, users can monitor and control output loudness levels based on the Linear Acoustic AEROMAX parameters.

### Fiber Connectivity

The addition of Grass Valley fiber interface modules enables your to extend the fiber capability of your facility. In addition to the SFP-supported fiber I/O in KudosPro products, adding Grass Valley IQ modular fiber transmitters, transceivers and receivers into the KudosPro-IQ unit allows further fiber interworking within a fully fiber or mixed copper/fiber environment.

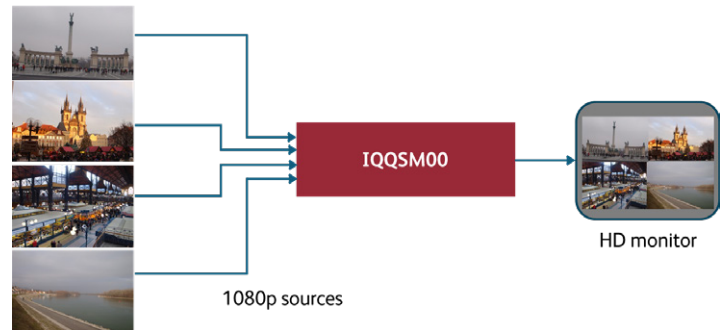

Application Example: Quad split monitor.

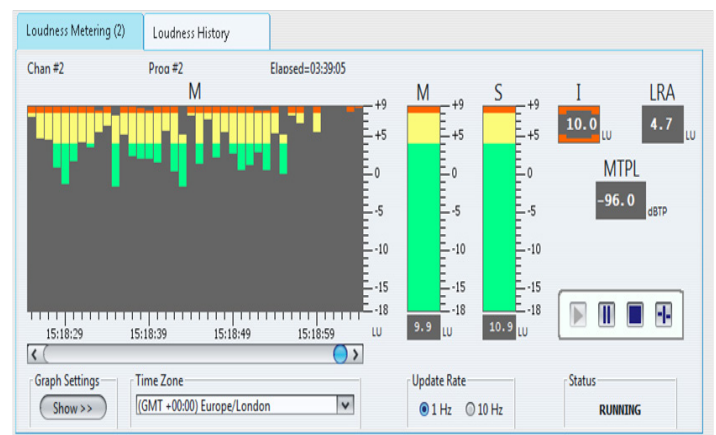

Application Example: Loudness monitoring.

## Application Example: Adding IQOTX80 — 3G/HD/SD-SDI Multichannel Fiber Transmitter

The IQOTX80-84 range converts eight 3G/HD/SD-SDI signals into single-mode fiber optic signals. The unit is available in single- or dual-width versions with either DIN1.0/2.3, HDBNC or BNC connectors with a range of fiber wavelength transmitters suitable for CWDM applications.

**KudosPro-IQ Application:** IQOTX80-84 can be added at the output stage of the KudosPro-IQ unit to enable extension of the fiber transmission capabilities, in addition to the SFP fiber options available. KudosPro SFP TX options are limited to 1310 nm, so if you need other fiber capability such as 1550 nm optical transmitters, 1270-1410 nm CWDM optical transmitters or 1470-1610 nm CWDM optical transmitters, addition of modules from the IQOTX80-84 range significantly enhances the fiber transmission capability.

Example A shows how you can add an IQCWD09 and a single width IQOTX8079-1B3 (HD-BNC & LC/PC) (Adapter cables can be ordered separately).

In the case that the CWDM is housed in a separate enclosure or a third-party device, then the IQOTX8080-2B3 (double width) with BNC connectors can be used as an alternative (Example B).

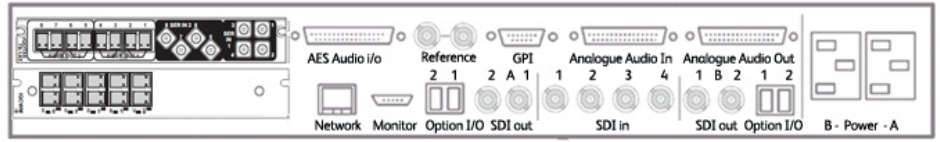

Example A — single width.

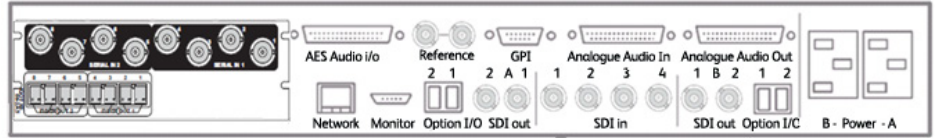

Example B — double width.

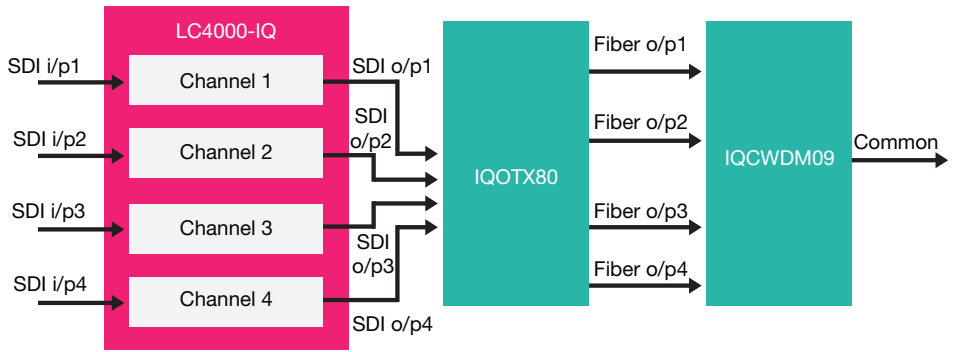

LC4000-IQ with fiber extension using IQOTX80.

## Cost-effective Conversion

Integrating international programming into your schedules has never been easier. With Grass Valley's KudosPro range of converters, you're guaranteed to find a converter to meet your application and your budget needs. Whether you need to convert frame rates or formats, Grass Valley offers motion compensated and motion adaptive converters that ensure the quality of your content is retained at every step in your workflow.

The IQ modular variant of KudosPro includes two single-width IQ modular slots that are accessed via the rear panel. Alternatively, a double-width module may be installed in the lower slot. Note that a double-width IQ Module will physically take up both slots, so only one double-width IQ Module can be installed.





# KudosPro-IP

## Video and Audio Processing for IP Systems

KudosPro-IP provides compact and affordable video and audio processing for IP-oriented applications.



### KEY FEATURES

- Quad-channel SD/HD/3G up-, down- and crossconversion, and processing over dual 10 GbE IP links
- Multiple transport types available for each processing channel including:
  - Compressed IP transport using SMPTE ST 2042 (VC2) low-latency high-quality encoding profile
  - Uncompressed video transport using either VSF TR-03 and TR-04 RTP (upgradeable to SMPTE ST 2110), or SMPTE ST 2022-6 encapsulation
  - PCM audio using TR-03 & AES67
  - SMPTE ST 291 metadata support via IETF standard “RTP Payload for Ancillary Data”
- Supports unicast as well as IGMPv3 source specific multicast, allowing point to point operation or transmission in multicast groups
- Supports configuration of Ethernet links for maximum signal transport using both SFPs, or for dual link mode to provide link redundancy as per SMPTE ST 2022-7
- 16-channel embedded audio processing for each video channel
- Automatic aspect ratio conversion (AFD, VI, L23)
- Powerful picture enhancement tools and clean-cut mode
- Closed caption and timecode handling
- Caption generator
- Logo inserter, sidebar keyer and HDMI monitoring output

### Applications

- Easily integrate common broadcast processing tasks into IP workflows

### Cost-effective conversion

Integrating international programming into your schedules has never been easier. With Grass Valley’s KudosPro range of converters, you’re guaranteed to find a converter to meet your application and your budget needs. Whether you need to frame rate or format convert, Grass Valley offers motion-compensated and motion-adaptive converters that ensure that the quality of your content is retained at every step in your workflow.

The IQ Modular variant of KudosPro includes two single-width IQ Modular slots that are accessed via the rear panel. Alternatively, a double-width module may be installed in the lower slot. Note that a double-width IQ Module will physically take up both slots, so only one double-width IQ Module can be installed.

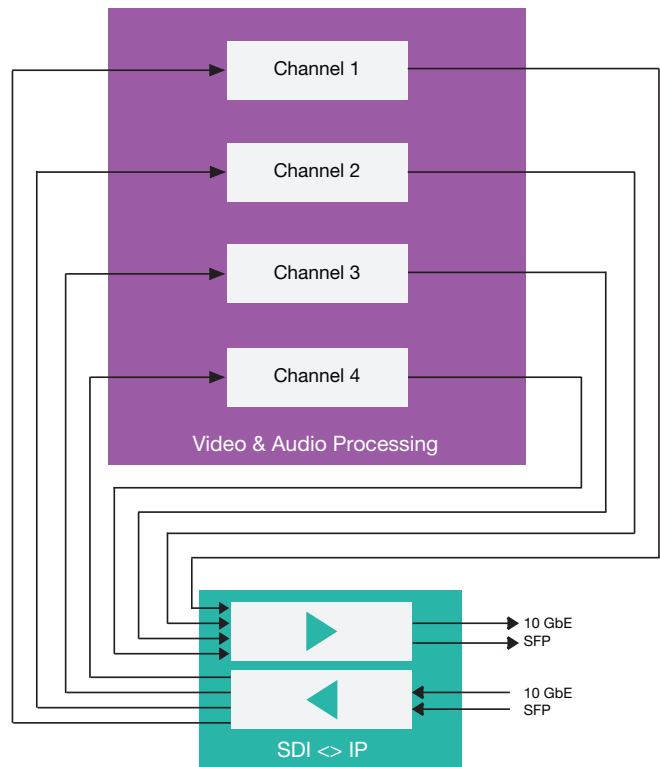



KudosPro-IP-LC/SV Video Processing

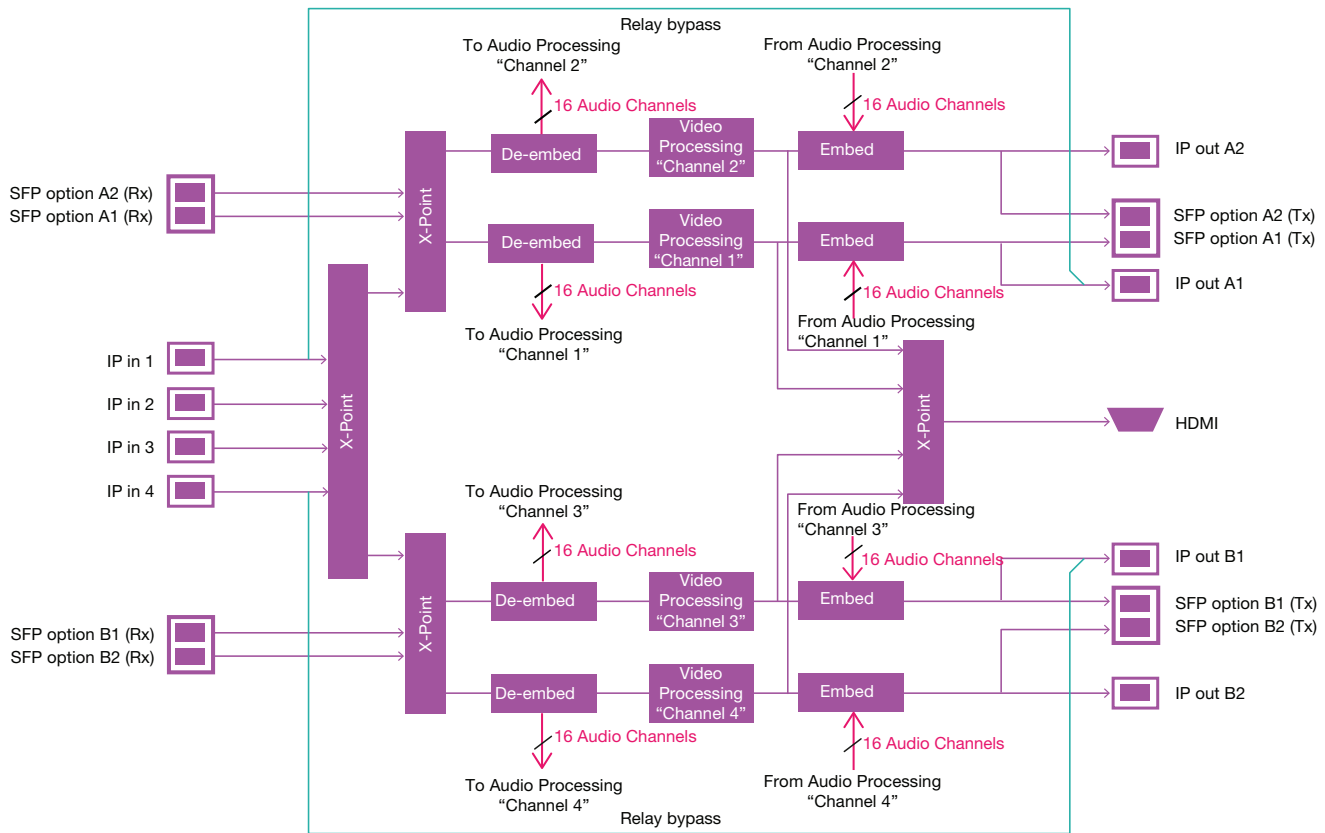

KudosPro-IP-LC/SV Audio Processing

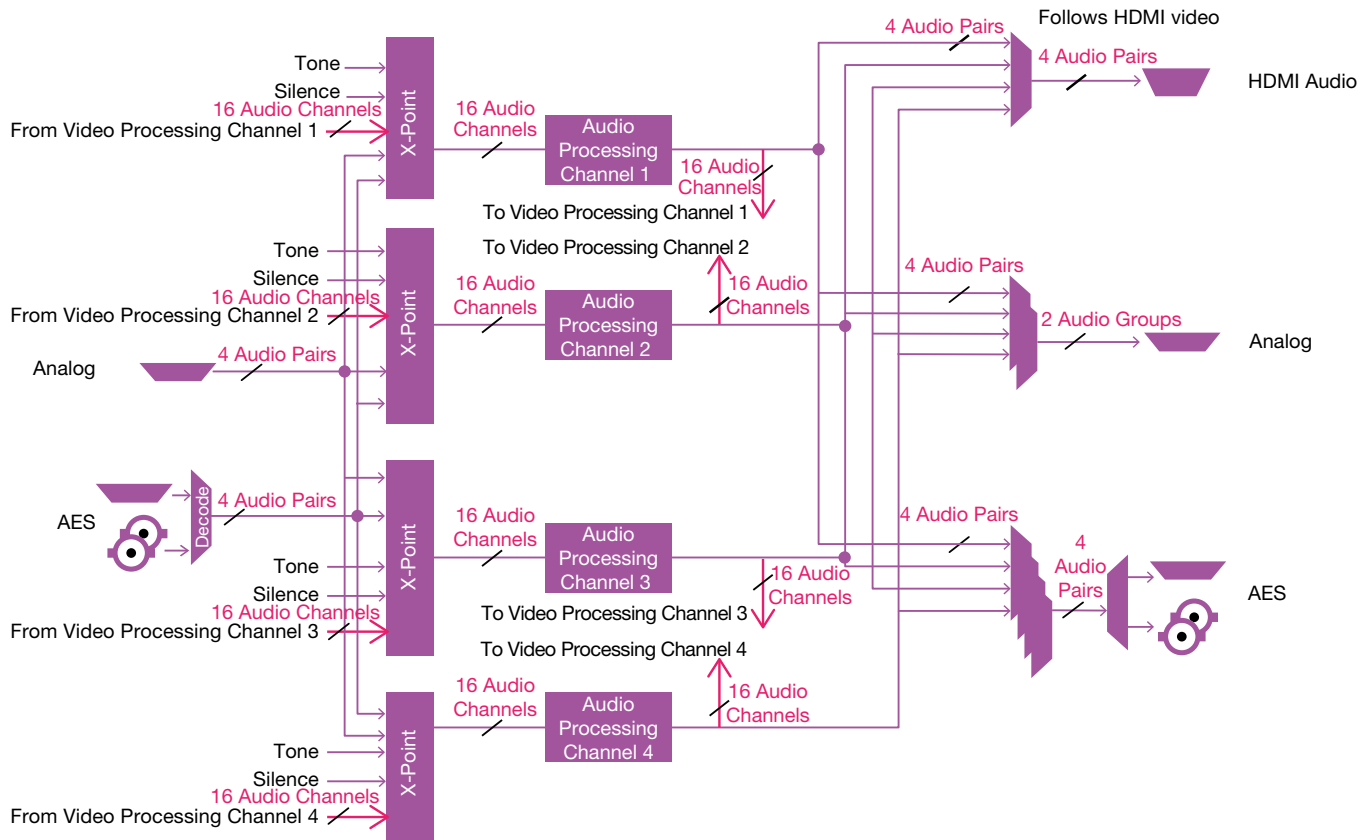

## SPECIFICATIONS

### Ethernet Signal

#### SFP+ Optical 2x 10G Ethernet

Conforms to IEEE 802.3ae – 10 GbE over fiber

#### SFP+ connected cable 2x 10G Ethernet

Conforms to IEEE 802.3ak – 10 GbE over twinaxial cables

**Note:** SFP type must be ordered in addition to the module.

### Signal Inputs

4x SD/HD/3G serial digital with embedded audio

#### Input standards:

- 3 Gb/s SD-SDI, SMPTE ST 425 level A, level B
- 1.5 Gb/s HD-SDI SMPTE ST 292 / SMPTE ST 299
- 270 Mb/s SD-SDI SMPTE ST 259

**Reference:** 1x loop-through HDTV Trisync/SD Bi-sync (black & burst) SMPTE ST 240/SMPTE ST 274

**Audio AES:** 4x balanced AES inputs via 25-way D-Type

**Audio Analog:** 4x stereo analog inputs via 25-way D-Type

### Signal Outputs

4 SD/HD/3G serial digital with embedded audio

#### Output standards:

- 3 Gb/s HD-SDI, SMPTE ST 425 level A, level B
- 1.5 Gb/s HD-SDI SMPTE ST 292 / SMPTE ST 299
- 270 Mb/s SD-SDI SMPTE ST 259

**Audio AES:** 4x balanced AES outputs via 25-way D-Type

**Audio analog:** 2x stereo analog outputs via 25-way D-Type

### Input Standards

(Auto detect) 525, 625

720 50/59.94/60p

1080 50/59.94/60i

1080 50/59.94/60p (Levels A and B)

720/1080 23/24/25/29/30p

1080 23/24/25/29psf

### Output Standards

525, 625

720 50/59.94/60p

1080 50/59.94/60i

1080 50/59.94/60p (Levels A and B)

720/1080 23/24/25/29/30p

1080 23/24/25/29psf

### Conversion Functions

**Modes:** SD/HD/3G Upconversion, Downconversion, Crossconversion at the same frame rate

#### Manual or Automatic ARC

**AFD:** (SMPTE ST 2016), VI (RP186), WSS (L23)

**SD input format:** Normal 4:3, Anamorphic 16:9, Letterbox 14:9, Letterbox 16:9

**SD output format:** Normal 4:3, Anamorphic 16:9, Letterbox 14:9, Letterbox 16:9

**Auto zoom:** On/Off

**Manual zoom:** Zoom  $\pm 20\%$

**Safe area marker:** Off, 16:9, 4:3

**Manual controls:** size, aspect, pan, tilt

Wide range of ARC presets including 702 sample line mode

### Audio Functions

#### Analog Audio:

Four pairs of analog inputs are individually available to any or all processing channels

Two groups (2 pairs) of analog output are separately assignable to any processing channel

Headroom +24 dBu; balanced connection

#### AES Audio:

Four AES audio inputs are individually available to any or all processing channels

Four AES audio outputs (48 kHz) are separately assignable to any processing channel  
AES input is auto-detected as PCM (32-96 kHz) or non-PCM (48 kHz locked to relevant video input)

#### Embedded Audio:

Each processing channel includes 16-channel embedded audio processing

PCM audio processing includes channel level gain and delay compensation, as well as channel level routing/shuffle with audio phase inversion

Non-PCM processing features pair level routing and delay compensation

Dolby-E data is passed with a delay to match the video and with co-timed audio frame drop or repeat

#### Dolby-E:

Optional single channel Dolby-E passing in convert mode on SV2000-IQ

SV4000-IQ has option of single channel Dolby-E passing on two processing channels

### Metadata

Closed caption CEA608 <> CEA708

Timecode conversions

WST/RDD8 conversion

SMPTE ST 2020 embed/de-embed

### Enhancement

#### Advanced Horizontal Enhancement:

Frequency band selection (Low, Med, High)

4 preset enhancement levels (Low, Med, High, Super)

Custom H Gain and H Noise rejection levels

#### Advanced Vertical Enhancement:

Frequency band selection (Low, Med, High)

5 preset enhancement levels (Soft 2, Soft 1, Normal, Sharp 1, Sharp 2)

#### Horizontal Aperture:

5 preset H sharpness levels (Low 2, Low 1, Normal, High 1, High 2)

5 preset H detail levels (Soft 2, Soft 1, Normal, Sharp 1, Sharp 2)

#### Noise reduction: spatial, recursive

### System

Pattern Off, Black, Ramp, Bars

Proc amp

**Black Level:** +100 to -100 mV (0) in 0.8 mV steps

**Contrast:** -6 dB to +6 dB (0) in 0.2 dB steps

**Saturation:** -6 dB to +6 dB (0) in 0.2 dB steps

**Y Gamma:** 0.4 to 1.7 (1) in 0.1 steps

**Freeze:** On/Off

**Genlock:** Reference lock, Input lock (same format), Follow input (same frame rate), Free run

**Memories:** 16 user memories

Legalizer

EDH support

### Communications

Remote control via web interface and RollCall network (IP)

### Power (Primary and Secondary)

**Input voltage range:** 100 – 240 VAC, 50/60 Hz 1.5A (max.) via three-pin IEC power socket

### Mechanical

**Temperature range:** 0 to 45° C (32° to 113° F) operating

**Cooling:** Internal fan, side venting

**Weight:** Approximately 4.25 kg (9.4 lbs.)

**Case type:** 1 RU, rack mounting

**Dimensions:** 44 x 430 x 400 mm (1.73 x 16.9 x 15.7 in.) (HxWxD)

Headphones socket with volume control

**GPIO:** 8 available

## ORDERING

### KPRO-IPMC210

**KudosPro-IP-MC:** Dual-channel video & audio processing unit with integrated IP interfacing module. Featuring motion compensated frame rate/format conversion, frame synchronization, ARC control, noise reduction, side-bar keying, logo insertion, CC, WST and timecode handling, picture enhancement tools, 16-channel audio processing inc gain, delay & shuffling. 10 GbE IP (SMPTE ST 2022-6, SMPTE ST 2110, TR-03, VC2), GPI, balanced AES and analog audio I/O. HDMI monitor output & dual PSUs.

### KPRO-IPLC410

**KudosPro-IP-LC:** Quad channel video & audio processing unit with integrated IP interfacing module. Featuring linear frame rate/format conversion, frame synchronization, ARC control, noise reduction, side-bar keying, logo insertion, CC, WST and timecode handling, picture enhancement tools, 16-channel audio processing inc gain, delay & shuffling. 10 GbE IP (SMPTE ST 2022-6, SMPTE ST 2110, TR-03, VC2), GPI, balanced AES and analog audio I/O. HDMI monitor output & dual PSUs.

### KPRO-IPSV410

**KudosPro-IP-SV:** Quad channel video & audio processing unit with integrated IP interfacing module. Featuring format conversion, frame synchronization, ARC control, noise reduction, side-bar keying, logo insertion, CC, WST and timecode handling, picture enhancement tools, 16-channel audio processing inc gain, delay & shuffling. 10 GbE IP (SMPTE ST 2022-6, SMPTE ST 2110, TR-03, VC2), GPI, balanced AES and analog audio I/O. HDMI monitor output & dual PSUs.



WWW.GRASSVALLEY.COM

Join the Conversation at [GrassValleyLive](#) on Facebook, Twitter, YouTube and [Grass Valley - A Belden Brand](#) on LinkedIn.



[www.grassvalley.com/blog](http://www.grassvalley.com/blog)

Belden, Belden Sending All The Right Signals, the Belden logo, Grass Valley and the Grass Valley logo are trademarks or registered trademarks of Belden Inc. or its affiliated companies in the United States and other jurisdictions. Grass Valley products listed above are trademarks or registered trademarks of Belden Inc., GVBB Holdings S.A.R.L. or Grass Valley Canada. Belden Inc., GVBB Holdings S.A.R.L., Grass Valley Canada and other parties may also have trademark rights in other terms used herein.

Copyright © 2018 Grass Valley Canada. All rights reserved. Specifications subject to change without notice.

GVB-1-0730A-EN-DS